

UNICHOICETM
HOSPITAL WEAR



SURGICAL GOWNS, DRAPES & PACKS



ARVIND MAFATLAL GROUP
The ethics of excellence

MAFATLAL INDUSTRIES LIMITED



ARVIND MAFATLAL GROUP
The ethics of excellence

UNICHOICETM
HOSPITAL WEAR



MEDIMAFTM
SURGICAL
DISPOSABLE

COPYRIGHT NOTICE

© 2019 MAFATLAL INDUSTRIES LIMITED, MUMBAI, INDIA

No part of this uniform Garment design book including the Garment patterns/designs may be reproduced or copied in any form or by any means including but not limited to graphic, electronic or mechanical, photocopying, recording, taping or information retrieval systems or reproduced on any disc, tape, perforated media or other information storage device etc., without the written permission of the owner of the Copyright i.e. Mafatlal Industries Limited, Mumbai. Breach of this condition is liable for appropriate civil and/or criminal legal action.



About Us

Mafatlal Industries Ltd was established in 1905, as one of the leading Textile Mills in the country, serving the nation since last 118 years with their fine Textile fabrics and a market leader in all kinds of Uniforms.

Recently Mafatlal Industries Limited brought to the market the most comprehensive range of Disposable Healthcare, Hygiene and Wellness related apparels and accessories solutions.

Our products are manufactured in the state-of-the-art facility, using imported machinery and International standards under strict quality control. We use Medical Textiles and Performance Fabrics in the Infection Control Arena

OUR INFECTION CONTROL PLATFORM IS DIVIDED INTO 3 VARIANTS:

Medical Disposable Apparels

Medical Packaging

Wound care

Our USP is that all the products are produced in Positive Static Pressure Room facility with completely hands-free operation and having in-house ETO Sterilisation facility.

The products are designed to meet the specific needs of medical professionals in medical Institutions eliminating a major contamination worry in the Operation Theatre. We have adopted the primary principle of “Unconditional Customer Satisfaction” Mafatlal is always the solution partner of its customers by providing them with the best solutions and impact training that are results of several clinical studies.

Our goal is to reduce the cost of health services whilst increasing the safety of patients and healthcare personnel.



ARVIND MAFATLAL GROUP
The ethics of excellence



About Us

Mafatlal manufactures in an hygienic environment within an area of approximately 5000 sq. meters. All processes follow the requirements of ISO 9001-2018, ISO 13485, and CE standards. The sterile packaging area is a (Class 100,000) (Hepa filter) room divided into sections with controlled inputs and outputs.

Surgical Packs, Surgical Drapes, and Surgical Gowns produced with new technological machines are packaged and sterilised according to user demands. A wide range of product lines has been installed and sterilisation process is carried out with its own 350 cubic meter steriliser installed in house and all control tests are carried out daily in its own state of the art Laboratory. In addition they are validated from time to time in International accredited Laboratories.

OUR MISSION

Mafatlal was established to meet the needs of the sector, to produce high quality and best fitted products with innovative approaches, to contribute to customer satisfaction, safety and protection of human health.

OUR VISION

Leader in the sector, with sustainable R&D activities , example of customer–employee satisfaction and social responsibility , Mafatlal envisages to be a well recognised brand in the International market.

OUR VALUES

To ensure a sustainable growth with our customers, employees, suppliers and others stakeholders.

- 100% CUSTOMER SATISFACTION
- TRANSPARENCY AND RESPONSIBILITY
- LEGAL COMPLIANCE
- ENVIRONMENTAL AWARENESS
- SUSTAINABILITY



Page
01

SURGICAL GOWNS

Page
09

SURGICAL DRAPE SHEETS

Page
18

CARDIOLOGY

Page
22

GENRAL SURGERY

Page
28

NEUROSURGERY

Page
32

OBSTETRICS & GYNECOLOGY

Page
36

OPHTHALMOLOGY, ENT & DENTAL

Page
41

ORTHOPAEDICS

Page
55

UROLOGY

Page
61

ACCESSORIES

**EXE
E
D
M**

SURGICAL GOWNS



GOWNS



SMS SURGICAL GOWNS

BETTER FIT AND ADJUSTABLE

SMS gowns are roomier in the chest and sleeves to help provide a better fit. They also feature an adjustable velcro-style neck closure.

FLAME RESISTANT

SMS gowns are resistant to ignition. The fabric has a naturally low rate of flame spread and meets the Standard for Flammability of Clothing Textiles CPSC 16 CFR Part 1610.

LOW-LINTING

SMS gowns are low linting. Because they are made from polypropylene, the gowns are naturally low in lint.

THREE LAYERS OF PROTECTION

Our SMS technology utilizes three layers of fabric to provide a high level of fluid repellency. This helps provide a barrier to blood, body fluids and pathogens. The fabric features one densely- packed meltblown layer sandwiched between two strong, spunbond outer layers.

BREATHABLE AND MORE COMFORTABLE THAN OTHER SMS GOWNS

Moisture vapor escapes at nearly twice the rate as other SMS gowns, allowing you to remain more comfortable. We are committed to helping you select the best protection for each procedure. New enhancements to the WeCare Non- Reinforced AAMI Level 3 Surgical gown make it easier for you to find and select the appropriate level of protection :

- AAMI Level 3 and AAMI Level 4 Surgical Gown options
- Multiple size options to ensure the right fit at the right AAMI Level
- Quickly differentiate between AAMI Level 3 and AAMI Level 4 gowns based on the color coded packaging and the new royal blue color of our AAMI Level 3 Non - Reinforced Surgical Gown.

UNDERSTANDING THE AAMI STANDARDS

Know the difference. It's about your safety. All surgical gown manufacturers must meet a set of detailed standards set up by the Association for the advancement of Medical Instrumentation. (AAMI) This is considered the standard in surgical gown manufacturing. Based on objective tests, the standards measure barrier effectiveness against penetration from blood bodily fluids and other potentially infectious materials.



ARVIND MAFATLAL GROUP
The ethics of excellence



Selection of ANSI / AAMI PB70 standard recognized by the FDA

<p>Type of PPE Feature Tested Standard Designation Description</p> <p>Applicability</p>	<p>Gowns Liquid Barrier Performance AAMI PB70:2012 Classifies a gown's ability to act as a barrier to penetration by liquids or liquid-borne pathogens based on four levels. The critical protective zones for surgical and non-surgical gowns are defined differently E the standard. While the critical zones designate different protective areas for the different gowns, the levels of protection are the same for both surgical and non-surgical gowns</p> <p>Liquid barrier performance is not related to the strength of the material.</p>
<p>Level 1 Description</p> <p>Applicability</p>	<p>This standard references several other standards</p> <ul style="list-style-type: none"> • Used for MINIMAL risk situations • Provides a slight barrier to small amounts of fluid penetration • Single test of water impacting the surface of the gown material is conducted to asses barrier protection performance. <p>Basic care, standard hospital medical unit</p>
<p>Level 2 Description</p> <p>Applicability</p>	<ul style="list-style-type: none"> • Used in LOW risk situations • Provides a barrier to larger amounts of fluid penetration through splatter and some fluid exposure through soaking • Two tests are conducted to assess barrier protection performance: <ul style="list-style-type: none"> • Water impacting the surface of the gown material • Pressurizing the material <p>Blood draw from a vein, Suturing, Intensive care unit, Pathology lab</p>
<p>Level 3 Description</p> <p>Applicability</p>	<ul style="list-style-type: none"> • Used in MODERATE risk situations • Provides a barrier to larger amounts fluid penetration through splatter and more fluid exposure through soaking than Level 2 • Two tests are conducted to test barrier protection performance: <ul style="list-style-type: none"> • Water impacting the surface of the gown material • Pressurizing the material <p>Arterial blood draw, Inserting an IV, Emergency Room, Trauma</p>
<p>Level 4 Description</p> <p>Applicability</p>	<ul style="list-style-type: none"> • Used in HIGH risk situations • Prevents all fluid penetration for up to 1 hour • May prevent VIRUS penetration for up to 1 hour • in addition to the other tests conducted under levels 1-3, barrier level performance is tested with a simulated blood containing a virus. If no virus is found at the end of the test, the gown passes. <p>Pathogen resistance, Infectious diseases (non-airborne), Large amounts of fluid exposure over long periods</p>

BREATHABLE VIRAL BARRIER SURGEON GOWN

Medimaf BVB Gown

- Meets IS 17334, AAMI PB 70 level 4, EN 13795 global standards.⁽¹⁾
- Breathable and viral barrier high performance fabric, resistant to fluid penetration and blood strike through.
- Free from skin irritation, skin sensitisation and cytotoxicity.⁽²⁾
- Resistant to microbial penetration.⁽³⁾
- Virtually Lint free and abrasion resistant.⁽⁴⁾
- Ultrasonically sealed seams.
- Raglan Sleeves with comfortably knitted cuffs.
- Velcro Hook and loop for adjustable neckline.
- Book folded for aseptic handling and usage.
- EO Sterilised as per ISO11135 Standards.⁽⁵⁾
- Pouch packed in certified and validated medical grade packs.⁽⁶⁾



Material Colour & Texture



Raglan Sleeves



Ultrasonic Seam

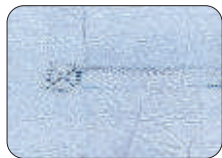

Ultrasonic Tie



Knitted Cuff

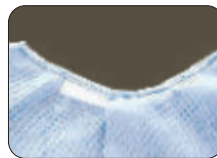

Velcro hook & loop

S.no	Product Name	Product Code	Product Size	Measurement
1	Medimaf*	MFSGE01S	Small	L-120 cm W - 160 cm
2		MFSGE01M	Medium	L-128 cm W- 160 cm
3		MFSGE01L	Large	L-135 cm W- 160 cm
4		MFSGE01X	X Large	L- 143 cm W- 160 cm
5		MFSGE01XX	XX Large	L - 150 cm W- 160 cm

OVER WRAP REINFORCED SURGEON GOWN

Medimaf Reinforced Gown

- Made from SMMS fabric which meets IS17334 , AAMI PB 70 level 3, EN 13795 standards. ⁽¹⁾
- Breathable fabric, resistance to fluid penetration and blood strike through.
- Free from skin irritation, skin sensitisation and cytotoxicity. ⁽²⁾
- Resistant to microbial penetration. ⁽³⁾
- Virtually lint free and abrasion resistant. ⁽⁴⁾
- Reinforced from neck line to cover the critical area and sleeve region.
- Ultrasonically sealed seams.
- Set in Sleeves with comfortably knitted cuffs.
- Velcro Hook and loop for adjustable neckline.
- Book folded for aseptic handling and usage.
- EO Sterilised as per ISO 11135 Standards. ⁽⁵⁾

Pouch packed in certified and validated medical grade packs. ⁽⁶⁾



Material Colour & Texture



Ultrasonic Seam



Ultrasonic Tie

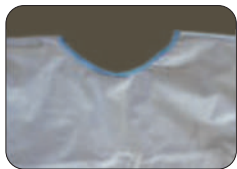

Neck line Reinforcement



Knitted Cuff

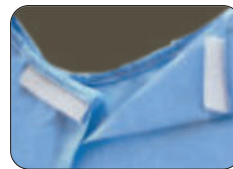

Velcro hook & loop

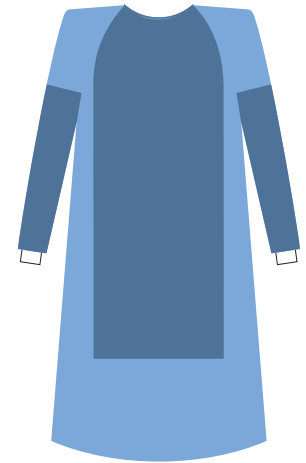

S.no	Product Name	Product Code	Product Size	Measurement
1	Medimaf Assure RI*	MFSGAR02S35	Small	L-120 cm W - 160 cm
		MFSGAR02S43		
2		MFSGAR02M35	Medium	L-128 cm W- 160 cm
		MFSGAR02M43		
3		MFSGAR02L35	Large	L-135 cm W- 160 cm
		MFSGAR02L43		
4	MFSGAR02X35	X Large	L- 143 cm W- 160 cm	
	MFSGAR02X43			
5	MFSGAR02XX35	XX Large	L - 150 cm W- 160 cm	
	MFSGAR02XX43			

OVER WRAP SURGEON GOWN

Medimaf Assure*

- Made from SMMS fabric which meets AAMI level 2 standards.
- Breathable fabric, resistance to fluid penetration and blood strike through.
- Free from skin irritation, skin sensitisation and cytotoxicity.⁽²⁾
- Resistant to microbial penetration.⁽³⁾
- Virtually lint free and abrasion resistant.⁽⁴⁾
- Non reinforced gown.
- Ultrasonically sealed seams.
- Set in Sleeves with comfortably knitted cuffs.
- Velcro Hook and loop for adjustable neckline.
- Book folded for aseptic handling and usage.
- EO Sterilised as per ISO11135 Standards.⁽⁵⁾
- Pouch packed in certified and validated medical grade packs.⁽⁶⁾

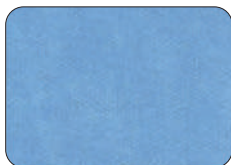

Material Colour & Texture



Ultrasonic Seam



Ultrasonic Tie



Knitted Cuff



Velcro hook & loop

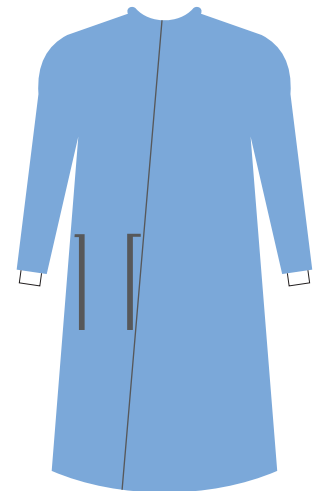

S.no	Product Name	Product Code	Product Size	Measurement
1	Medimaf Assure*	MFSGA03S35	Small	L-120 cm W - 160 cm
		MFSGA03S43		
2		MFSGA03M35	Medium	L-128 cm W- 160 cm
		MFSGA03M43		
3		MFSGA03L35	Large	L-135 cm W- 160 cm
		MFSGA03L43		
4	MFSGA03X35	X Large	L- 143 cm W- 160 cm	
	MFSGA03X43			
5	MFSGA03XX35	XX Large	L - 150 cm W- 160 cm	
	MFSGA03XX43			

MEDIMAF WRAPAROUND REINFORCED SURGEON GOWN

Medimaf Assure WR*

- Made from SMMS fabric which meets IS17334 , AAMI PB 70 level 3, EN 13795 standards. ⁽¹⁾
- Breathable fabric, resistance to fluid penetration and blood strike through.
- Free from skin irritation, skin sensitisation and cytotoxicity. ⁽²⁾
- Resistant to microbial penetration. ⁽³⁾
- Virtually lint free and abrasion resistant. ⁽⁴⁾
- Extra flap of fabric which extends over the waist for extra protection.
- Reinforced from neck line to cover the critical area and sleeve region.
- Ultrasonically sealed seams.
- Set in sleeves with comfortably knitted cuffs.
- Velcro Hook and loop for adjustable neckline.
- Book folded for aseptic handling and usage.
- EO Sterilised as per ISO11135 Standards. ⁽⁵⁾
- Pouch packed in certified and validated packs. ⁽⁶⁾



Material Colour & Texture



Ultrasonic seam



Ultrasonic Tie

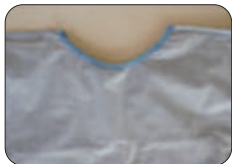

Neck line Reinforcement



Knitted Cuff



Velcro hook & loop

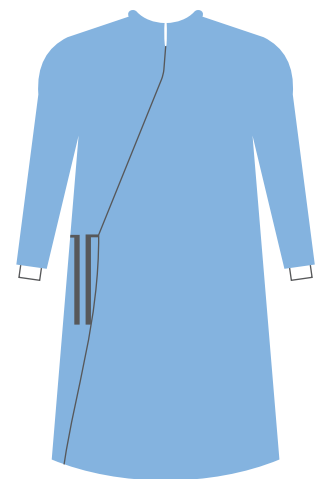

S.no	Product Name	Product Code	Product Size	Measurement
1	Medimaf Assure WR*	MFSGAWR04S35	Small	L-120 cm W - 160 cm
		MFSGAWR04S43		
2		MFSGAWR04M35	Medium	L-128 cm W- 160 cm
		MFSGAWR04M43		
3		MFSGAWR04L35	Large	L-135 cm W- 160 cm
		MFSGAWR04L43		
4		MFSGAWR04X35	X Large	L- 143 cm W- 160 cm
		MFSGAWR04X43		
5		MFSGAWR04XX35	XX Large	L - 150 cm W- 160 cm
		MFSGAWR04XX43		

MEDIMAF WRAPAROUND STANDARD GOWN

Medimaf Assure WA*

- Made from SMMS Fabric meets AAMI PB 70 level 2 standards.
- Breathable fabric, resistance to fluid penetration and blood strike through.
- Free from skin irritation, skin sensitisation and cytotoxicity.⁽²⁾
- Resistant to microbial penetration.⁽³⁾
- Virtually lint free and abrasion resistant.⁽⁴⁾
- Non reinforced gown.
- Ultrasonically sealed seams.
- Extra fabric around the waist for enhanced protection.
- Set-in sleeves with comfortably knitted cuffs.
- Velcro Hook and loop for adjustable neckline.
- Book folded for aseptic handling and usage.
- EO Sterilised as per ISO11135 Standards.⁽⁵⁾
- Pouch packed in certified and validated medical grade packs.⁽⁶⁾

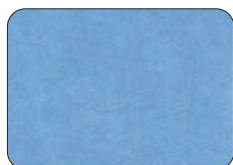

Material Colour & Texture



Ultrasonic Seam



Ultrasonic Tie



Knitted Cuff

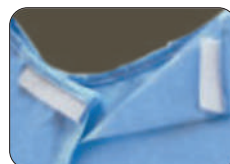

Velcro hook & loop

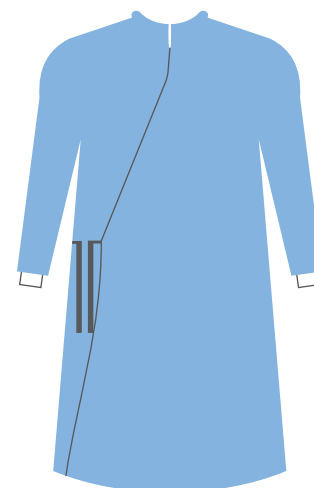

S.no	Product Name	Product Code	Product Size	Measurement
1	Medimaf Assure WA*	MFSGAW05S35 MFSGAW05S43	Small	L-120 cm W - 210 cm
2		MFSGAW05M35 MFSGAW05M43	Medium	L-128 cm W- 210 cm
3		MFSGAW05L35 MFSGAW05L43	Large	L-135 cm W- 210 cm
4		MFSGAW05X35 MFSGAW05X43	X Large	L - 143 cm W- 210 cm
5		MFSGAW05XX35 MFSGAW05XX43	XX Large	L - 150 cm W- 210 cm

SURGICAL DRAPES & PACKS



DRAPES & PACKS



ABOUT OUR DRAPES

THE BROADEST LINE IN THE INDUSTRY

We offer wide range of options, which is especially designed for each purpose. 2 - layers basic laminated materials is the exceptional feature of our Surgical drapes.

SOME BENEFITS OFFERED BY OUR PRODUCTS:

- 100% impermeable
- High absorption capacity and speed
- Low level of linting
- Strong and durable
- Soft feel and conforms easily to the body.
- Latex free.

ENHANCED DRAPE FEATURES INCLUDE :

- Royal blue colour for SMS drape fabric
- Helps reduce glare from operating lights
- Provides colour contrast between drape fabric and reinforced areas for visual definition of critical zone.
- Standardised absorbent reinforcement material in critical zones.
- Creates a more consistent look , feel, and experience for clinicians.
- Enhanced reinforcement sizing on select codes



ARVIND MAFATLAL GROUP
The ethics of excellence



THE HIGH STANDARD O.R. DRAPES AND GOWNS

OUR DESIGN :

All our drapes and gowns are developed with the help from Operation room Professionals around the globe. While designing and developing , we have tried to add as many features as much as possible for a better performance. The O.R. professionals have shared their experience with our team, so we did get a good sense of what features. Hence, Mafatlal developed an innovative line of products which can be used with confidence.

VELCRO STYLE LINE HOLDERS:

Drapes with Velcro-style tube and line holders to place surgical tools will help keep them clear of the working area. The Velcro is easy to use, even when wearing gloves. This is one of the key feature we have developed for the drapes.

TAPE AND INCISE FILM:

We use premium tape and incise film on all drapes. Our tape is manually placed to the fenestration which prevent pooling of blood and fluid underneath the drape. Since, the tape is placed manually, it allows the tape to be closer to the fenestration compared to other drapes.

LARGE IMPERVIOUS REINFORCEMENT ZONE:

Fenestrations and splits are surrounded with a large impervious reinforcement. This area absorbs fluids and is plastic-backed to make the area impervious to blood and body fluids as well as bacterial transmission.

- We understand that each O.R. team may have different preferences in a surgical gowns, that's why our gowns are available in different materials and in various combinations, to provide each user with the best fit.
- All gowns are cut wider in the chest and sleeves for a better fit. Our gown features an adjustable Velcro-style neck closure which allows the neckline to easily adjust to a wide variety of people, while also helping to prevent gapping in the front which serves as additional protection against fluids.



ARVIND MAFATLAL GROUP
The ethics of excellence



STERILE PROCEDURE TRAYS / PACKS

Today, there is increased pressure on hospital management to improve efficiency and reduce costs while minimising harm to the environment. Low prices alone are no longer enough.

You need :

- Products designed to make your process leaner.
- High Quality
- Environmentally friendly options

Mafatlal's Sterile procedure trays are compact ready to use which can be replaced with just one item instead of dozens.

Sterile procedure trays reduce set-up time, leaving more time for training patients. With fewer items to open, there is also a reduced risk of contamination. Procedure trays are assembled in dedicated clean rooms and undergo a validated ETO sterilisation process.

OUR RANGE OF PACKS

STANDARD PACKS

For commonly performed procedures, Mafatlal offers standard surgical packs. These Sterile Procedure Trays (SPT's) can help you save money, streamline your inventory and improve efficiency.

CUSTOMISED PROCEDURE TRAYS (CPT's)

In addition we offer customized packs, which allow you to select list of alternative components that are both clinically effective and cost efficient, without compromising the custom pack performance you expect from Mafatlal.



ARVIND MAFATLAL GROUP
The ethics of excellence



STERILE PROCEDURE TRAYS / PACKS

Mafatlal's surgical procedure packs provide the following attributes:

INFECTION PREVENTION:

Protect your healthcare teams and patients from infections both in the operating theatre and patient care units.

MEDICAL TEXTILES / PERFORMANCE APPARELS

We know you rely on disposable apparel to keep your staff protected and comfortable. For this reason, we use fine materials available for protection, offering a great level of comfort. We apply high quality standards to our products in our manufacturing facilities, Mafatlal is ISO 13485 certified.

HOW TO CHOOSE THE RIGHT MATERIAL ?

SPUNBOND POLYPROPYLENE :

The standard fabric for basic protective apparel is formed by bonding fibers together to form a single layer of breathable, woven like material. Its main advantages are economy and comfort.

MULTI - PLY MATERIAL (SMS) :

This fabric consists of inner layers of meltblown polypropylene sandwiched between outer layers of spunbond polypropylene. Strong fluid resistant and breathable, this multi-layer material provides an optimal mix of protection and comfort.

POLYETHYLENE :

This single layer of Polyethylene film provides high barrier properties at a very attractive price. This film is ideal for situations when impervious feature is needed.

PREVENTIVE PLUS :

This impervious and breathable material consists of a hybrid film laminated between two layers of bi-component spunbond material. This fabric is ideal for long interventions when impervious protection is needed.



ARVIND MAFATLAL GROUP
The ethics of excellence

GENERAL / UNIVERSAL DRAPE

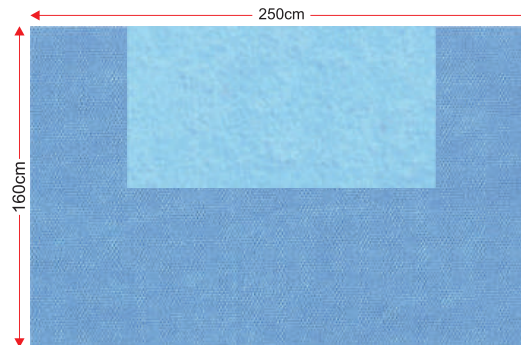

- Trinox Universal Drapes are available as Side Drape, Top Drape, Bottom Drape, Orthopaedic Bar Drape, OBG/Abdominal Drape.
- Universal Drapes are made from SMMS and Spunlace absorbent fabric with adhesive at longer edge.
- Universal Drapes meets AAMI level 3 standards.
- Resistance to fluid penetration and fluid concentration.
- Free from skin irritation, skin sensitisation and cytotoxicity.^{*(2)}
- Resistant to microbial penetration.^{*(3)}
- Virtually lint free and abrasion resistant.^{*(4)}
- EO Sterilised as per ISO11135 Standards.^{*(5)}
- Pouch packed in certified and validated packs.^{*(6)}

MFSD1610	Medimaf-Side Drape	160cm*100cm
MFTD2516	Medimaf-Top Drape	250cm*160cm
MFBD1616	Medimaf-Bottom Drape	160cm*160cm

PLAIN DRAPE SHEET WITHOUT ADHESIVE

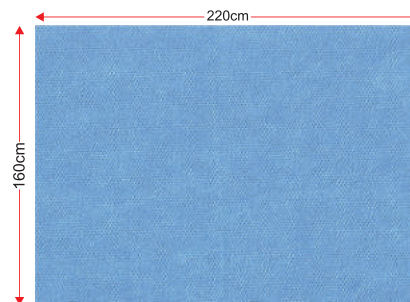

- Trinox Plain Drape sheets without adhesive, are made from SMMS non-woven fabric.
- Meets AAMI level 2 standards.
- Resistance to fluid penetration and blood strike through.
- Free from skin irritation, skin sensitisation and cytotoxicity.^{*(2)}
- Resistant to microbial penetration.^{*(1)}
- Virtually lint free and abrasion resistant.^{*(3)}
- EO Sterilised as per ISO11135 Standards.^{*(4)}
- Pouch packed in certified and validated medical grade packs.^{*(5)}

MFDA8010	Medimaf-Pain Drape Sheet without adhesive (Small Sheet)	80cm*100cm
MFDA1216	Medimaf-Pain Drape Sheet without adhesive (Medium Sheet)	120cm*160cm
MFDA2024	Medimaf-Pain Drape Sheet without adhesive (X large Sheet)	200cm*240cm

PLAIN DRAPE SHEET WITH ADHESIVE

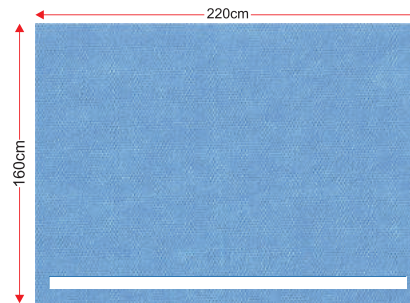

- Trinox Plain Drape sheets with adhesive on longer edge, are made from SMMS non-woven fabric.
- Meets AAMI level 2 standards.
- Resistance to fluid penetration and blood strike through.
- Free from skin irritation, skin sensitisation and cytotoxicity^{*(2)}
- Resistant to microbial penetration^{*(1)}
- Virtually lint free and abrasion resistant^{*(3)}
- EO Sterilised as per ISO11135 Standards.^{*(4)}
- Pouch packed in certified and validated medical grade packs^{*(5)}.

MFDWA8010	Medimaf-Pain Drape Sheet with adhesive (Small Sheet)	80cm*100cm
MFDWA1216	Medimaf-Pain Drape Sheet with adhesive (Medium Sheet)	120cm*160cm
MFDWA2024	Medimaf-Pain Drape Sheet with adhesive (X large Sheet)	200cm*240cm

ABSORBENT DRAPE SHEET WITHOUT ADHESIVE (ABS)

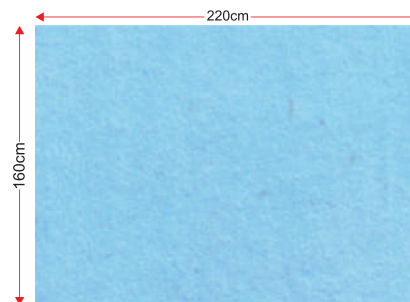

- Trinox Absorbent Drape sheets without adhesive, are made from absorbent non-woven fabric.
- Meets AAMI level 2 standards.
- Resistance to fluid penetration and blood strike through.
- Free from skin irritation, skin sensitisation and cytotoxicity^{*(2)}
- Resistant to microbial penetration^{*(1)}
- Virtually lint free and abrasion resistant^{*(3)}
- EO Sterilised as per ISO11135 Standards^{*(4)}
- Pouch packed in certified and validated medical grade packs^{*(5)}.

MFAS8010	Medimaf-Absorbent Drape Sheet without adhesive (Small Sheet)	80cm*100cm
MFAS1216	Medimaf-Absorbent Drape Sheet without adhesive (Medium Sheet)	120cm*160cm
MFAS2024	Medimaf-Absorbent Drape Sheet without adhesive (X large Sheet)	200cm*240cm

ABSORBENT DRAPE SHEET WITH ADHESIVE (ABS)

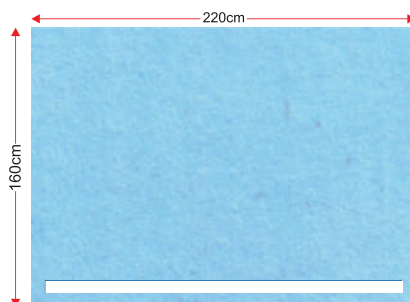

- Trinox Absorbent Drape sheets with adhesive on longer edge, are made from absorbent non-woven fabric.
- Meets AAMI level 2 standards.
- Resistance to fluid penetration and blood strike through.
- Free from skin irritation, skin sensitisation and cytotoxicity.^{*(2)}
- Resistant to microbial penetration.^{*(1)}
- Virtually lint free and abrasion resistant^{*(3)}
- EO Sterilised as per ISO11135 Standards.^{*(4)}
- Pouch packed in certified and validated medical grade packs^{*(5)}

MFASW8010	Medimaf-Absorbent Drape Sheet with adhesive (Small Sheet)	80cm*100cm
MFASW1216	Medimaf-Absorbent Drape Sheet with adhesive (Medium Sheet)	120cm*160cm
MFASW2024	Medimaf-Absorbent Drape Sheet with adhesive (X large Sheet)	200cm*240cm

FENESTRATED DRAPES

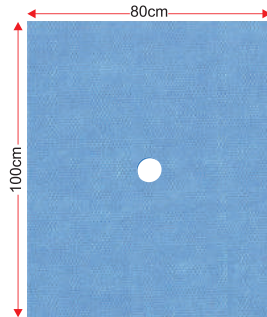

Product Name Medimaf - Fenestrated Drape

Size 80cm * 100cm

Product Code **MFFD8010**

Description

Used for minor surgical procedure, having fenestration of 3" diameter with adhesive around fenestration

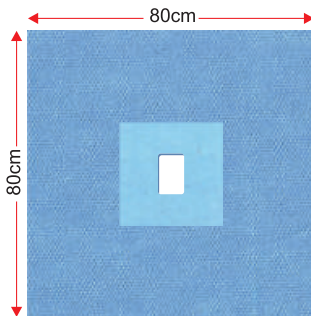

Product Name Medimaf - Fenestrated Drape

Size 80cm * 80cm

Product Code **MFFDR8080**

Description

Surgical drape having fenestration of 9cm*5cm with adhesive around fenestration. Reinforced with spunlace absorbent.

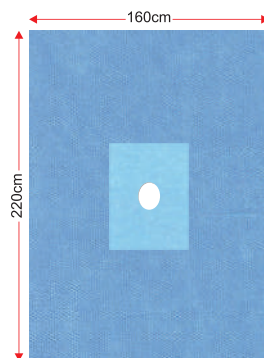

Product Name Medimaf - Fenestrated Drape

Size 220cm * 160cm

Product Code **MFAD2216**

Description

Surgical drape having fenestration of 8" diameter having adhesive around fenestration. Reinforced with spunlace absorbent.



DRAPES & PACKS

■ CARDIOLOGY

CARDIOLOGY DRAPES

Medimaf Cardiology drapes made from polypropylene SMMS non-woven fabric, absorbent non-woven fabric, helps to isolate the surgical site from the other areas of the patient's body and nonsterile areas of the OR table to contribute to reducing the risk of surgical site infection (SSI). The fabrics meet IS17334, AAMI PB 70, EN13795 standards ⁽¹⁾. The fabric used in making the drapes are resistant to fluid penetration, fluid concentration, and blood strike-through, they are free from skin irritation, skin sensitization, and cytotoxicity. ⁽²⁾ also resist microbial penetration ⁽³⁾, virtually lint-free, and abrasion-resistant ⁽⁴⁾. Trinox Cardiology drapes are pouch packed in certified and validated packs that meet EN868 -5 and ISO 11607-1 standard ⁽⁵⁾ and finally, EO Sterilised as per ISO 11135 standards. ⁽⁶⁾

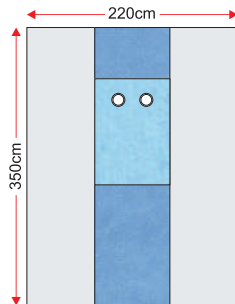

Product Name

Medimaf - Femoral Angiography Drape Ultra

Size

350cm * 220cm

Product Code

MFFAD3522

Description

Medimaf Femoral Angiography Drape Ultra of size 350cm*220cm having two femoral fenestration of 8cm diameter, reinforced with absorbent layer for better fluid absorbency, transparent plastic windows on both side of the drape.

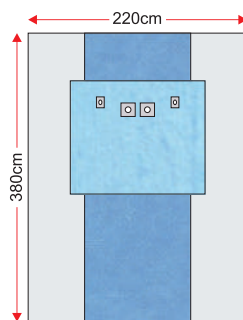

Product Name

Medimaf - Radial Femoral Angiography Darpe

Size

380cm * 220cm

Product Code

MFFAR3822

Description

Medimaf Radial Angiography Drape of size 380cm*220cm having femoral Circular fenestration of 8cm, and radial oval fenestration of lenth 9cm, reinforced with absorbent layer for better fluid absorbency, transparent plastic windows on both side of the drape.

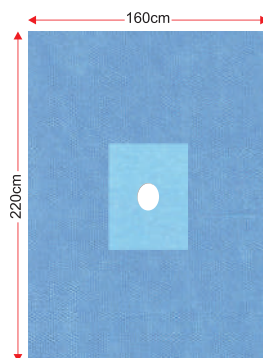

Product Name

Medimaf - Fenestrated Drape

Size

220cm * 160cm

Product Code

MFAD2216

Description

Surgical drape having fenestration of 8" diameter having adhesive aroundfenestration. Reinforced with spunlace absorbent.

ANGOGRAPHY PROCEDURE ULTRA PACK

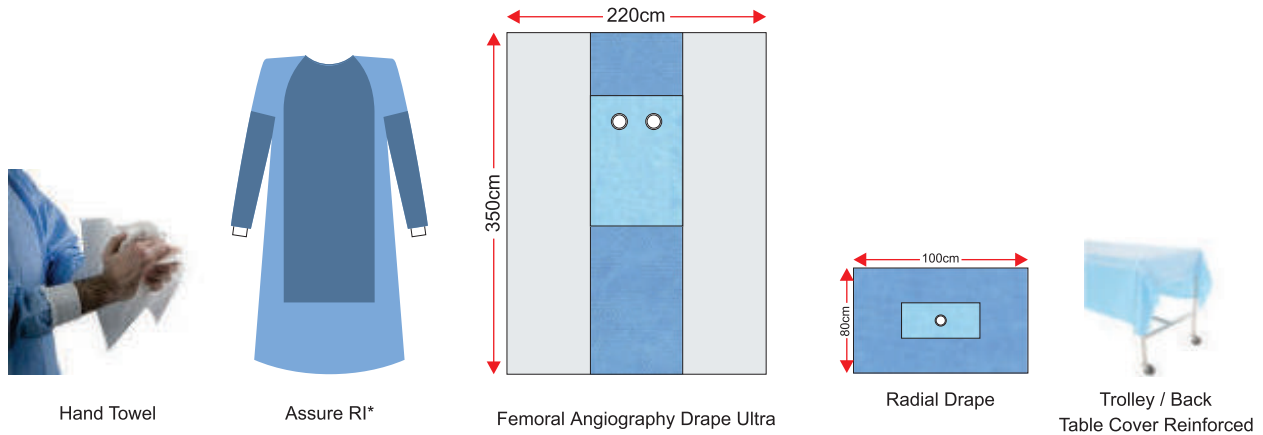

Pack Code	MF01002S			
Pack Name	Medimaf*- Angiography Ultra Pack			
S.no	Product Description	Product Code	Product Size	Qty.
1	Medimaf* Assure RI	MFSGAR02M43 MFSGAR02L43	Medium Large	2
2	Medimaf * - Hand Towel	MFHT3030	30 cm * 30 cm	4
3	Medimaf * - Femoral Angiography Drape Ultra	MFAD3522	350 cm * 220 cm	1
4	Medimaf * - Radial Drape	MFRD8010	80 cm * 100 cm	1
5	Medimaf * - Trolley / Back Table Cover Reinforced	MFTRL16225	160 cm * 225 cm (Large)	1

ANGOGRAPHY PROCEDURE PACK

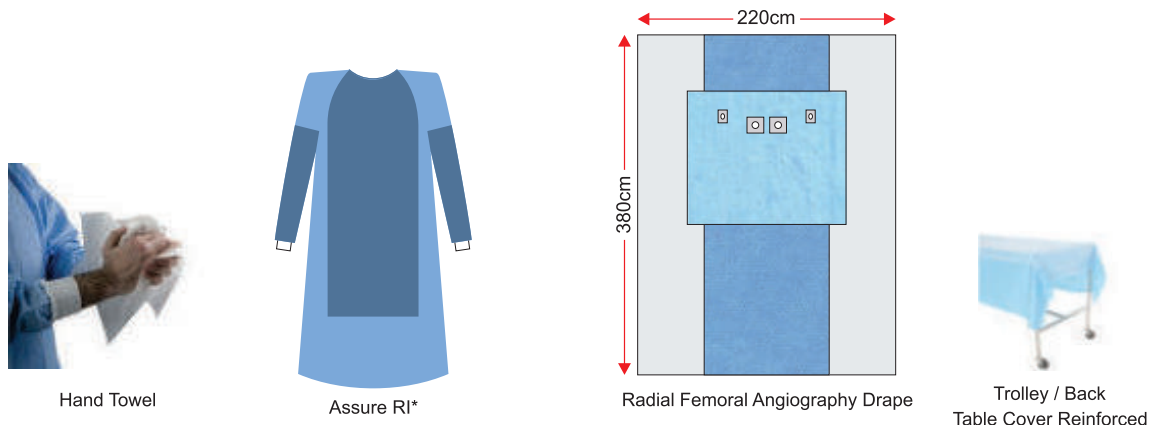

Pack Code	MF01003S			
Pack Name	Medimaf*- Angiography Pack			
S.no	Product Description	Product Code	Product Size	Qty.
1	Medimaf* Assure RI	MFSGAR02M43 MFSGAR02L43	Medium Large	2
2	Medimaf * - Hand Towel	MFHT3030	30 cm * 30 cm	4
3	Medimaf * - Radial Femoral Angiography Drape	MFAR3822	380 cm * 220 cm	1
4	Medimaf * - Trolley / Back Table Cover Reinforced	MFTRL16225	160 cm * 225 cm (Large)	1

CVTS PROCEDURE PACK 3



Hand Towel



Assure RI

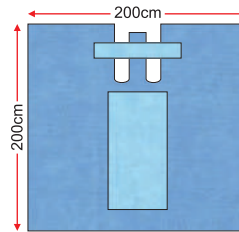

Bilateral Under Leg Drape

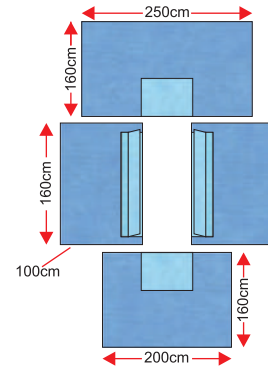

CVT Universal Drape



Instrument / Cautery Bag



Mayo Trolley Cover Reinforced



Trolley / Back Table Cover Reinforced

Pack Code		MF01008S		
Pack Name		Medimaf* - CVTS Procedure Pack 3		
S.no	Product Description	Product Code	Product Size	Qty.
1	Medimaf* Assure RI	MFSGAR02M43 MFSGAR02L43	Medium Large	5
2	Medimaf* - Hand Towel	MFHT3030	30 cm * 30 cm	10
3	Medimaf* - Bilateral Under Leg Drape	MFBL2020	200 cm * 200 cm	1
4	Medimaf* - CVT Universal Drape	MFCVTD01	For product size refer Pg.No 30	1
5	Medimaf* - Instrument / Cautery Bag	MFCB01	30 cm * 40 cm	2
6	Medimaf* - Mayo Trolley Cover Reinforced	MFMTTR8080	80 cm * 80 cm	1
7	Medimaf* - Basin Stand	MFBS8010	80 cm * 100 cm	1
8	Medimaf* - Trolley / Back Table Cover Reinforced	MFTRL16225	160 cm * 225 cm (Large)	2

GENERAL SURGERY



DRAPES & PACKS

LAPAROTOMY DRAPES

Medimaf Laparotomy Drapes made from polypropylene SMMS non-woven fabric, absorbent non-woven fabric, helps to isolate the surgical site from the other areas of the patient's body and nonsterile areas of the OR table to contribute to reducing the risk of surgical site infection (SSI). The fabrics meet IS17334, AAMI PB 70, EN13795 standards⁽¹⁾. The fabric used in making the drapes are resistant to fluid penetration, fluid concentration, and blood strike-through, they are free from skin irritation, skin sensitization, and cytotoxicity.⁽²⁾ also resist microbial penetration⁽³⁾, virtually lint-free, and abrasion-resistant⁽⁴⁾. Laparotomy Drapes are pouch packed in certified and validated packs that meet EN868 -5 and ISO 11607-1 standard⁽⁵⁾ and finally, EO Sterilised as per ISO 11135 standards.⁽⁶⁾

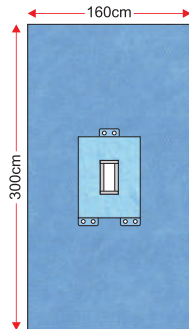

Product Name Medimaf - Laparotomy Drape

Size 300cm * 160cm

Product Code MFLP3016

Description

Medimaf Laparotomy Drape of size 300cm * 160cm, having fenestration size of 30cm * 15cm with adhesive around fenestration, reinforced with spunlace absorbent laminate around fenestration for better fluid absorbency, supported with tube holder for tube and cord organiser.

LAPAROSCOPY DRAPES

Medimaf Laparoscopy Drapes made from polypropylene SMMS non-woven fabric, absorbent non-woven fabric, helps to isolate the surgical site from the other areas of the patient's body and nonsterile areas of the OR table to contribute to reducing the risk of surgical site infection (SSI). The fabrics meet IS17334, AAMI PB 70, EN13795 standards⁽¹⁾. The fabric used in making the drapes are resistant to fluid penetration, fluid concentration, and blood strike-through, they are free from skin irritation, skin sensitization, and cytotoxicity.⁽²⁾ also resist microbial penetration⁽³⁾, virtually lint-free, and abrasion-resistant⁽⁴⁾. Laparoscopy Drapes are pouch packed in certified and validated packs that meet EN868 -5 and ISO 11607-1 standard⁽⁵⁾ and finally, EO Sterilised as per ISO 11135 standards.⁽⁶⁾

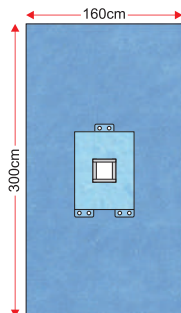

Product Name Medimaf - Laparoscopy Darpe

Size 300cm * 160cm

Product Code MFLD3016

Description

Medimaf Laparoscopy Drape of size 300cm * 160cm, having fenestration size of 30cm * 30cm with adhesive around fenestration, reinforced with spunlace absorbent laminate around fenestration for better fluid absorbency, also supported with tube holder for tube and cord organiser.

GENERAL SURGERY MAJOR PACK



Hand Towel

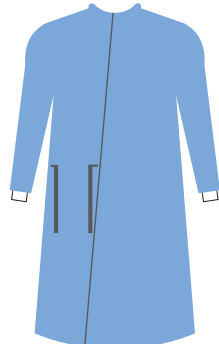

Assure*

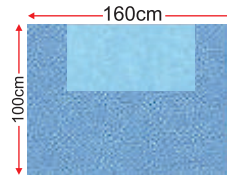

Side Drape

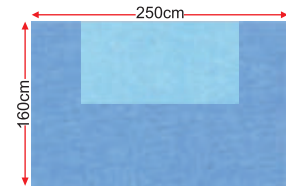

Top Drape

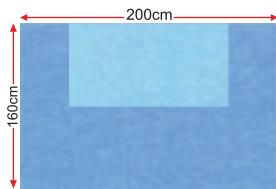

Bottom Drape

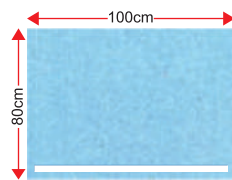

Absorbent Drape sheet with adhesive (Small sheet)



Instrument / Cautery Bag



Trolley / Back Table Cover

Pack Code		MF04001S		
Pack Name		Medimaf* - General Surgery Major Pack		
S.no	Product Description	Product Code	Product Size	Qty.
1	Medimaf Assure*	MFSGA03M43 MFSGA03L43	Medium Large	3
2	Medimaf* - Hand Towel	MFHT3030	30cm * 30cm	6
3	Medimaf* - Side Towel	MFSD1610	160cm * 100cm	2
4	Medimaf* - Top Towel	MFTD2516	250cm * 160cm	1
5	Medimaf* - Bottom Towel	MFTD2016	200cm * 160cm	1
6	Medimaf* - Absorbent Drape Sheet with adhesive (Small Sheet)	MFASW1080	100cm * 80cm	1
7	Medimaf* - Instrument / Cautery Bag	MFCB01	40cm * 30cm	1
8	Medimaf* - Trolley / Back Table Cover Reinforced	MFTSM1615	160cm * 150cm (Medium)	1

GENERAL SURGERY MINOR PACK



Hand Towel

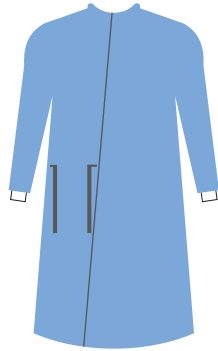

Assure*

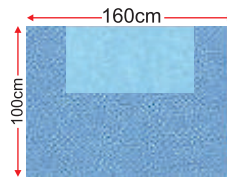

Side Drape

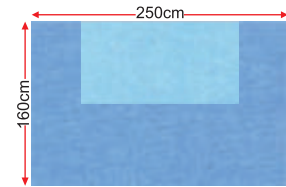

Top Drape

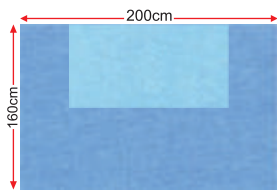

Bottom Drape

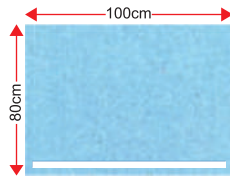

Absorbent Drape sheet with adhesive (Small sheet)



Instrument / Cautery Bag



Trolley / Back Table Cover

Pack Code		MF04002S		
Pack Name		Medimaf* - General Surgery Minor Pack		
S.no	Product Description	Product Code	Product Size	Qty.
1	Medimaf Assure*	MFSGA03M43 MFSGA03L43	Medium Large	3
2	Medimaf* - Hand Towel	MFHT3030	30cm * 30cm	6
3	Medimaf* - Plain Drape Sheet with Adhesive (Large Sheet)	MFDWA221643	220cm * 160cm	1
4	Medimaf* - Plain Drape Sheet with Adhesive (Medium Sheet)	MFDWA161243	160cm * 120cm	2
5	Medimaf* - Plain Drape Sheet with Adhesive (Small Sheet)	MFDWA108043	100cm * 80cm	2
6	Medimaf* - Absorbent Drape Sheet with Adhesive (Small Sheet)	MFASW1080	100cm * 80cm	1
7	Medimaf* - Instrument / Cautery Bag	MFCB01	40cm * 30cm	1
8	Medimaf* - Trolley / Back Table Cover Reinforced	MFTSM1615	160cm * 150cm (Medium)	1

LAPAROTOMY PROCEDURE PACK



Hand Towel

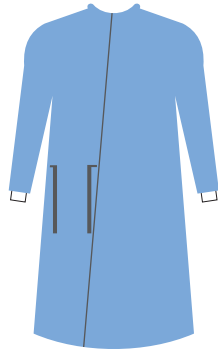

Assure*

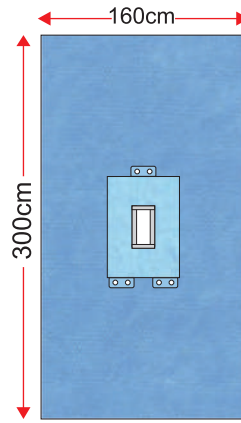

Laparotomy Drape



Instrument / Cautery Bag



Mayo Trolley Cover



Trolley / Back Table Cover

Pack Code		MF04005S		
Pack Name		Medimaf* - Laparotomy Pack		
S.no	Product Description	Product Code	Product Size	Qty.
1	Medimaf Assure*	MFSGA03M43 MFSGA03L43	Medium Large	3
2	Medimaf* - Hand Towel	MFHT3030	30 cm * 30 cm	6
3	Medimaf* - Laparotomy Drape	MFLP3016	300 cm * 160 cm	1
4	Medimaf* - Instrument / Cautery Bag	MFCB01	40 cm * 30 cm	1
5	Medimaf* - Mayo Trolley Cover	MFMTTC8080	80 cm * 80 cm	1
6	Medimaf* - Trolley / Back Table Cover	MFTSM1615	160 cm * 150 cm (Medium)	1

LAPAROSCOPY PROCEDURE PACK



Hand Towel

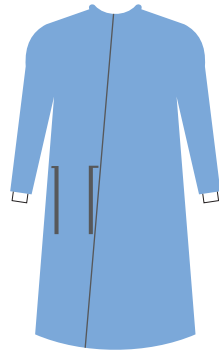

Assure*

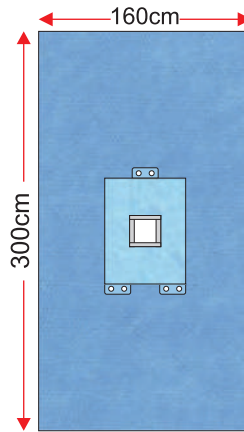

Laparoscopy Drape

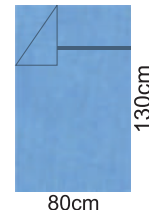

Leggings



OP Release Tape



Instrument / Cautery Bag



Endoscopy / Camera Drape



Mayo Trolley Cover



Trolley / Back Table Cover

Pack Code		MF05001S		
Pack	Name	Medimaf* - Laparoscopy Pack		
S.no	Product Description	Product Code	Product Size	Qty.
1	Medimaf Assure*	MFSGA03M43 MFSGA03L43	Medium Large	2
2	Medimaf* - Hand Towel	MFHT3030	30 cm * 30 cm	4
3	Medimaf* - Laparotomy Drape	MFLP3016	300 cm * 160 cm	1
4	Medimaf* - Leggings	MFLG01P	130 cm * 80 cm	1 Pair
5	Medimaf* - OP Release Tape	MFOP0515	5 cm * 15 cm	4
6	Medimaf* - Instrument / Cautery Bag	MFCB01	40 cm * 30 cm	2
7	Medimaf* - Endoscopy / Camera Drape	MFEDC01	Width 15 cm * Length 250 cm	1
8	Medimaf* - Mayo Trolley Cover	MFMTC8080	80 cm * 80 cm	1
9	Medimaf* - Trolley / Back Table Cover	MFTSM1615	160 cm * 150 cm (Medium)	1

NEUROSURGERY



DRAPES & PACKS

NEUROSURGERY DRAPES

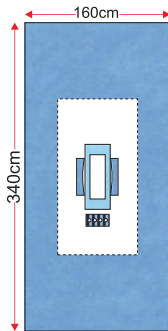

Product Name Medimaf - Lamino Spinal Drape SD

Size 340cm * 160cm

Product Code **MFLSD3416**

Description

Medimaf Lamino Spinal drape SD of size 340cm * 160cm having fenestration size of 35cm * 17cm with incise film and adhesive tape around fenestration, reinforced for better protection from fluid penetration and concentration, supported with attached fluid collection pouch having one suction port, 2 pockets for instrument placement, tube holders for tube and cord organiser.

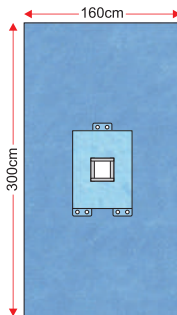

Product Name Medimaf - Laparoscopy Darpe

Size 300cm * 160cm

Product Code **MFLD3016**

Description

Medimaf Lamino Spinal drape SD of size 340cm * 160cm having fenestration size of 35cm * 17cm with incise film and adhesive tape around fenestration, reinforced with spunlace absorbent around fenestration, backdrop reinforced for better protection from fluid penetration and concentration. supported with 2 pockets for placing instruments, tube holders for tube and cord organiser.

NEUROSURGERY PROCEDURE PACK



Hand Towel



Assure RI*

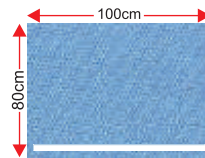

Plain Drape Sheet with Adhesive (Small Sheet)

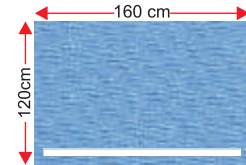

Plain Drape Sheet with adhesive (Medium Sheet)

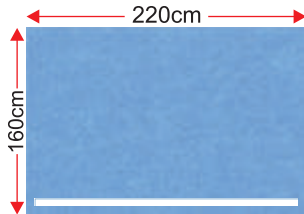

Plain Drape Sheet with adhesive (Large Sheet)



Instrument / Cautery Bag



Mayo Trolley Cover



Trolley / Back Table Cover

Pack Code		MF06001S		
Pack Name		Neurosurgery Procedure Pack		
S.no	Product Description	Product Code	Product Size	Qty.
1	Medimaf Assure RI*	MFSGAR02M43 MFSGAR02L43	Medium / Large	3
2	Medimaf* - Hand Towel	MFHT3030	30 cm * 30 cm	6
3	Medimaf* - Plain Drape Sheet With Adhesive (Small Sheet)	MFDWA108043	100cm*80cm	4
4	Medimaf* - Plain Drape Sheet With Adhesive (Medium Sheet)	MFDWA161243	160 cm* 120 cm	2
5	Medimaf* - Plain Drape Sheet With Adhesive (Large Sheet)	MFDWA221643	220 cm* 160 cm	5
6	Medimaf* - Instrument / Cautery Bag	MFCB01	40 cm * 30 cm	1
7	Medimaf*- Mayo Trolley Cover	MFMTTC8080	80 cm * 80 cm	2
8	Medimaf*- Trolley / Back Table Cover	MFTSL16225	160 cm * 225 cm (Large)	2

LAMINO SPINAL PROCEDURE SD DRAPE PACK



Hand Towel

Assure RI*

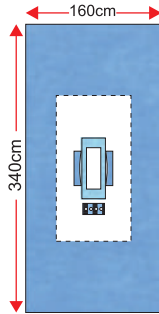

Lamino Spinal Drape SD

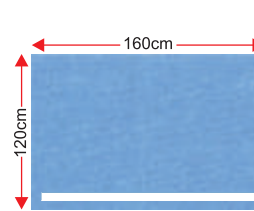

Plain Drape Sheet with adhesive (Medium Sheets)

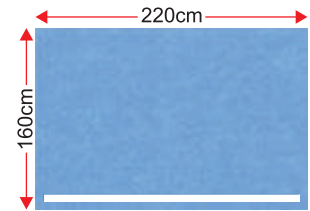

Plain Drape Sheet with adhesive (Large Sheet)



C- Arm Drape



Mayo Trolley Cover Reinforced



Trolley / Back Table Cover Reinforced

Pack Code		MF06003S		
Pack Name		Lamino Spinal Procedure SD Drape Pack		
S.no	Product Description	Product Code	Product Size	Qty.
1	Medimaf Assure RI*	MFSGAR02M43 MFSGAR02L43	Medium / Large	3
2	Medimaf* - Hand Towel	MFHT3030	30 cm * 30 cm	6
3	Medimaf* - Plain Drape Sheet With Adhesive (Medium Sheet)	MFDWA161245	160 cm * 120 cm	2
4	Medimaf* - Plain Drape Sheet With Adhesive (Large Sheet)	MFDWA221643	220 cm * 160 cm	2
5	Medimaf* - Lamino Spinal Drape SD	MFLSD3416	340 cm * 160 cm	1
6	Medimaf* - C- Arm Drape	MFCAC012P	Standard - 1 Pair	1
7	Medimaf* - Mayo Trolley Cover Reinforced	MFMTTR8080	80 cm * 80 cm	2
8	Medimaf* - Trolley / Back Table Cover Reinforced	MFTRM1615	160 cm * 150 cm (Medium)	1
9	Medimaf* - Trolley / Back Table Cover Reinforced	MFTRL16225	160 cm * 225 cm (Large)	1

OBSTETRICS & GYNECOLOGY



DRAPES & PACKS

OBSTETRICS & GYNECOLOGY DRAPES

Medimaf Gynecology drapes made from polypropylene SMMS non-woven fabric, absorbent non-woven fabric, helps to isolate the surgical site from the other areas of the patient's body and nonsterile areas of the OR table to contribute to reducing the risk of surgical site infection (SSI). The fabrics meet IS17334, AAMI PB 70, EN13795 standards ⁽¹⁾. The fabric used in making the drapes are resistant to fluid penetration, fluid concentration, and blood strike-through, they are free from skin irritation, skin sensitization, and cytotoxicity. ⁽²⁾ also resist microbial penetration ⁽³⁾, virtually lint-free, and abrasion-resistant ⁽⁴⁾. Gynecology drapes are pouch packed in certified and validated packs that meet EN868 -5 and I ⁽⁵⁾ ⁽⁶⁾

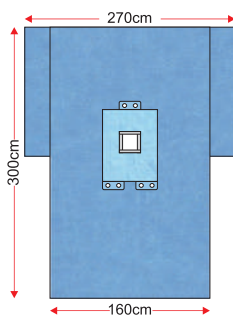

Product Name Medimaf - C- Section Drape

Size 300cm * 260cm * 270cm

Product Code MFCST3016

Description

Medimaf C Section drape of size 300cm * 160cm * 270cm with arm board coverage, having square fenestration of size 30cm * 30cm with incise film and adhesive around fenestration, reinforced with spunlace absorbent around fenestration for better fluid absorbency, supported with tube holder for tube and cord organiser.

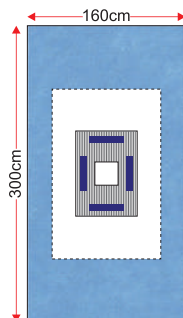

Product Name Medimaf - C-Section Drape with fluid collection pouch

Size 300cm * 160cm

Product Code MFCSF3016

Description

Medimaf C- Section drape with fluid collect pouch of size 300cm * 160cm, having fenestration of 30cm * 30cm with adhesive around fenestration, backdrop reinforced for enhanced protection from fluid penetration and concentration during surgery. Supported with fluid collection pouch and suction port, tube holder for tube and cord organiser.

NORMAL DELIVERY PROCEDURE PACK



Hand Towel

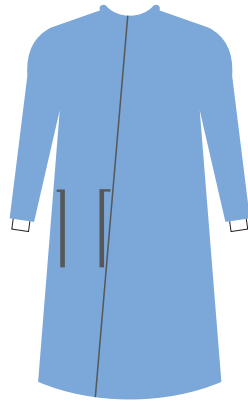

Assure*



Underbuttock Absorbent Pad

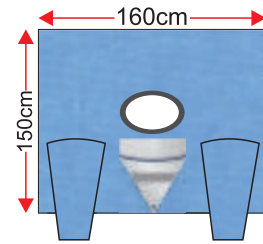

Normal Delivery Drape



Cord Clamp

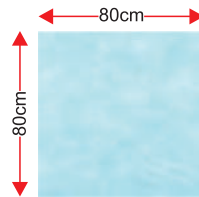

Baby Receiving Sheet



Trolley / Back Table Cover

Pack Code		MF07001S		
Pack	Name	Medimaf* - Normal Delivery Pack		
S.no	Product Description	Product Code	Product Size	Qty.
1	Medimaf Assure RI*	MFSGA03M43 MFSGA03L43	Medium Large	3
2	Medimaf* - Hand Towel	MFHT3030	30 cm * 30 cm	3
3	Medimaf* - Underbuttock Absorbent Pad	MFUDP6090	60 cm * 90 cm	1
4	Medimaf* - Normal Delivery Drape	MFND1615	160 cm * 150 cm	1
5	Cord Clamp	MFCL01	Standard	1
6	Medimaf* - Baby Receiving Sheet	MFBRW01	80cm * 80 cm	2
7	Medimaf* - Trolley / Back Table Cover	MFTSM1615	160 cm * 150 cm (Medium)	1

CAESAREAN SECTION PROCEDURE PACK WITH FLUID COLLECTION POUCH



Hand Towel

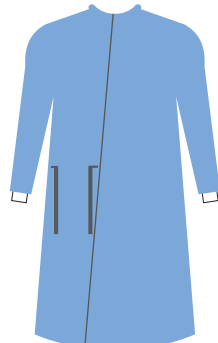

Assure *

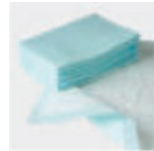

Underbuttock Absorbent Pad

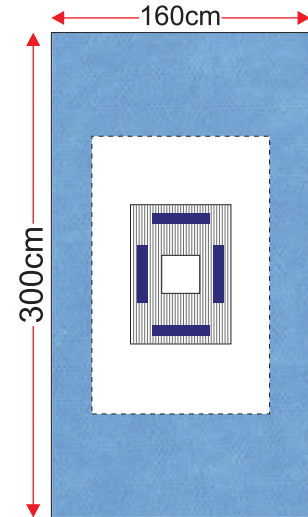

C-Section Drape with fluid collection pouch



Instrument / Cautery Bag



Cord Clamp

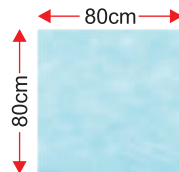

Baby Receiving Sheet



Mayo Trolley Cover



Trolley / Back Table Cover

Pack Code		MF07003S		
Pack Name		Medimaf* - LSCS Procedure Pack with Fluid collection Pouch		
S.no	Product Description	Product Code	Product Size	Qty.
1	Medimaf Assure*	MFSGA03M43 MFSGA03L43	Medium Large	3
2	Medimaf* - Hand Towel	MFHT3030	30 cm * 30 cm	3
3	Medimaf* - Underbuttock Absorbent Pad	MFUDP6090	60 cm * 90 cm	1
4	Medimaf* - C-Section Drape with fluid collection Pouch	MFCSF3016	300 cm * 160 cm	1
5	Medimaf* - Instrument / Cautery Bag	MFCB01	40cm * 30 cm	1
6	Cord Clamp	MFCL01	Standard	1
7	Medimaf* - Baby Receiving Sheet	MFBRW01	80cm * 80 cm	2
8	Medimaf* - Mayo Trolley Cover	MFMTTC8080	80 cm * 80 cm	1
9	Medimaf* - Trolley / Back Table Cover	MFTSM1615	160 cm * 150 cm(Medium)	1

OPHTHALMOLOGY, ENT & DENTAL



DRAPES & PACKS

OPHTHALMOLOGY, ENT & DENTAL DRAPES

Medimaf Ophthalmic, ENT and Dental drapes made from polypropylene SMMS non-woven fabric, absorbent non-woven fabric, helps to isolate the surgical site from the other areas of the patient's body and nonsterile areas of the OR table to contribute to reducing the risk of surgical site infection (SSI). The fabrics meet IS17334, AAMI PB 70, EN13795 standards. The fabric used in making the drapes are resistant to fluid penetration, fluid concentration, and blood strike-through, they are free from skin irritation, skin sensitization, and cytotoxicity.^{1,2} also resist microbial penetration³, virtually lint-free, and abrasion-resistant⁴. Trinox Ophthalmic, ENT and Dental drapes are pouch packed in certified and validated packs that meet EN868 -5 and ISO 11607-1 standard⁵ and finally, EO Sterilised as per ISO 11135 standards.⁶

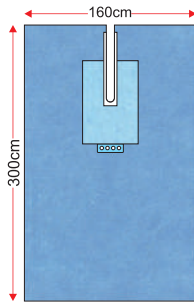

Product Name Medimaf - ENT Split Drape

Size 300cm * 160cm

Product Code MFESD3016

Description Medimaf ENT Split Drape of size 300cm * 160cm having U split of 10cm * 60cm, reinforced with spunlace absorbent for better fluid absorbency with adhesive around the split for securing the drape for procedure. Drape is supported with tube holder for organising tubes and cords during procedure

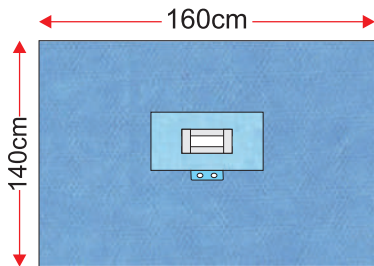

Product Name Medimaf - Dental Drape

Size 160cm * 140cm

Product Code MFDD1614

Description Medimaf Dental Drape of size 160cm * 140cm having fenestration of size 12cm * 12cm, reinforced with spunlace absorbent laminate for better fluid absorbency with adhesive around fenestration.

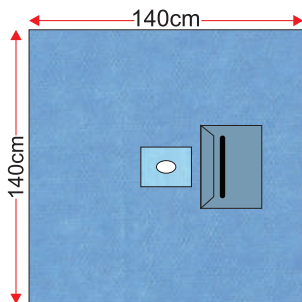

Product Name Medimaf -Ophthalmic Drape SP

Size 140cm * 140cm

Product Code MFOD1414

Description Trinox Ophthalmic drape SP of size 140cm * 140cm, having fenestration of size 9cm * 7cm reinforced with absorbent layer and supported with incise film, attached with fluid collection pouch

OPHTHALMOLOGY, ENT & DENTAL DRAPES

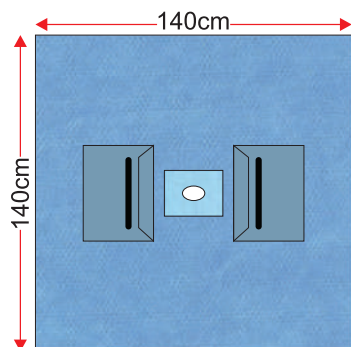

Product Name Medimaf - Ophthalmic Drape DP

Size 140cm * 140cm

Product Code MFODD1414

Description

Trinox Ophthalmic drape DP of size 140cm * 140cm, having fenestration of size 9cm * 7cm reinforced with absorbent layer and supported with incise film, attached with dual fluid collection pouch.

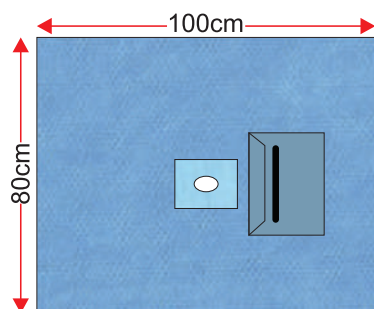

Product Name Medimaf - Ophthalmic Drape

Size 100cm * 80cm

Product Code MFOD1080

Description

Trinox Ophthalmic drape of size 100cm * 80cm, having fenestration of size 9cm * 7cm reinforced with absorbent layer and supported with incise film, attached with fluid collection pouch

ENT, HEAD & NECK PROCEDURE PACK



Hand Towel

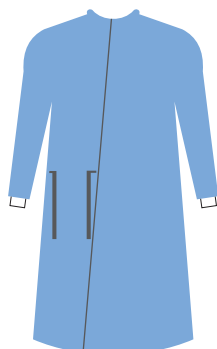

Assure*

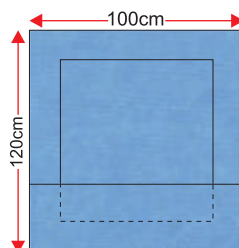

Head Drape with Turban

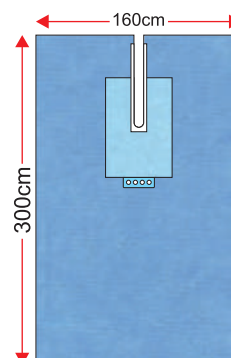

ENT Split Drape



Instrument / Cautery Bag



Mayo Trolley Cover



Trolley / Back Table Cover

Pack Code	MF03001S			
Pack Name	Medimaf* - ENT, Head and Neck Procedure Pack			
S.no	Product Description	Product Code	Product Size	Qty.
1	Medimaf Assure*	MFSGA03M43 MFSGA03L43	Medium Large	3
2	Medimaf* - Hand Towel	MFHT3030	30cm * 30cm	3
3	Medimaf* - Head Drape with Truban	MFHDT1210	120cm * 100cm	1
4	Medimaf* - ENT Split Drape	MFESD3016	300cm * 160cm	1
5	Medimaf* - Instrument / Cautery Bag	MFCB01	30cm * 40cm	1
6	Medimaf* - Mayo Trolley Cover	MFMTTC8080	80cm * 80cm	1
7	Medimaf* - Trolley / Back Table Cover	MFTSM1615	160cm * 150cm (Medium)	1

ENT, HEAD & NECK PROCEDURE PACK



Hand Towel

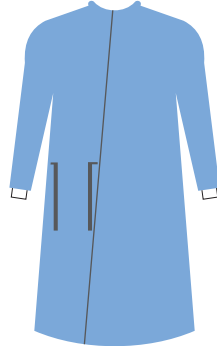

Assure*

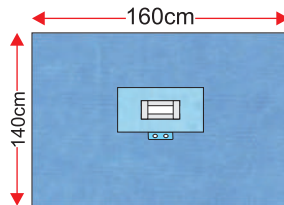

Dental Drape

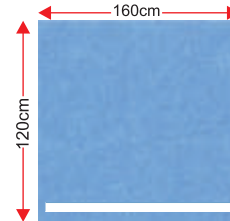

Plain Drape Sheet with adhesive (Medium sheet)



Trolley / Back Table Cover

Pack Code	MF02001S			
Pack Name	Medimaf* - Deental Procedure Pack			
S.no	Product Description	Product Code	Product Size	Qty.
1	Medimaf Assure*	MFSGA03M43 MFSGA03L43	Medium Large	2
2	Medimaf* - Hand Towel	MFHT3030	30cm * 30cm	2
3	Medimaf* - Plain Drape Sheet with adhesive(Medium)	MFDDWA1612	160cm * 120cm	1
4	Medimaf* - Dental Drape	MFDD1614	160cm * 140cm	1
5	Medimaf* - Trolley / Back Table Cover	MFTSS8075	80cm * 75cm (Small)	1
6	Medimaf* - Trolley / Back Table Cover	MFTSM1615	160cm * 150cm (Medium)	1

OPHTHALMOLOGY PROCEDURE PACK



Hand Towel

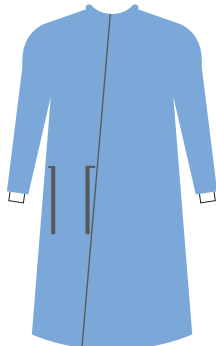

Assure*

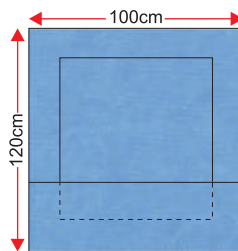

Head Drape with Turban

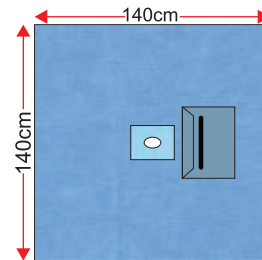

Ophtalmic Drape SP



Trolley / Back Table Cover

Pack Code	MF08001S			
Pack Name	Medimaf* - Ophtalmic Procedure Pack 1			
S.no	Product Description	Product Code	Product Size	Qty.
1	Medimaf Assure*	MFSGA03M43 MFSGA03L43	Medium Large	2
2	Medimaf* - Hand Towel	MFHT3030	30cm * 30cm	2
3	Medimaf* - Head Drape with Truban	MFHDT1210	160cm * 120cm	1
4	Medimaf* - Ophtalmic Drape SP	MFOD1414	160cm * 140cm	1
5	Medimaf* - Trolley / Back Table Cover	MFTSS8075	80cm * 75cm (Small)	1
6	Medimaf* - Trolley / Back Table Cover	MFTSM1615	160cm * 150cm (Medium)	1

ORTHOPAEDICS



DRAPES & PACKS

ARTHROSCOPY DRAPES

Medimaf Arthroscopy drapes made from polypropylene SMMS non-woven fabric, absorbent non-woven fabric, helps to isolate the surgical site from the other areas of the patient's body and nonsterile areas of the OR table to contribute to reducing the risk of surgical site infection (SSI). The fabrics meet IS17334, AAMI PB 70, EN13795 standards™ The fabric used in making the drapes are resistant to fluid penetration, fluid concentration, and blood strike-through, they are free from skin irritation, skin sensitization, and cytotoxicity.^{***21} also resist microbial penetration^{***3}, virtually lint-free, and abrasion-resistant^{***4}. Arthroscopy drapes are pouch packed in certified and validated packs that meet EN868 -5 and ISO 11607-1 standard^{**15} and finally, EO Sterilised as per ISO 11135 standards.^{**16}

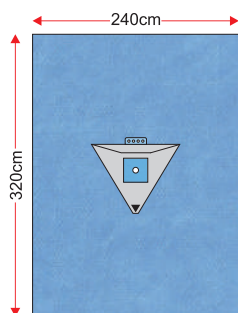

Product Name Medimaf - Knee Arthroscopy Drape Ultra

Size 320cm * 240cm

Product Code MFKAD3224

Description

Medimaf Knee Arthroscopy Drape Ultra of size 320cm * 240cm, reinforced with latex-free material having a center hole of 2.5-inch diameter, backdrop reinforced, to prevent fluid penetration and concentration. Attached with a fluid collection pouch having a suction port. Supported with tube holder for tube and cord organizer.

HIP DRAPES

Medimaf HIP drapes made from polypropylene SMMS non-woven fabric, absorbent non-woven fabric, helps to isolate the surgical site from the other areas of the patient's body and nonsterile areas of the OR table to contribute to reducing the risk of surgical site infection (SSI). The fabrics meet IS17334, AAMI PB 70, EN13795 standards. The fabric used in making the drapes are resistant to fluid penetration, fluid concentration, and blood strike-through, they are free from skin irritation, skin sensitization, and cytotoxicity. also resist microbial penetration³, virtually lint-free, and abrasion-resistant⁴. HIP drapes are pouch packed in certified and validated packs that meet EN868 -5 and ISO 11607-1 standard⁵ and finally, EO Sterilised as per ISO 11135 standards.⁶

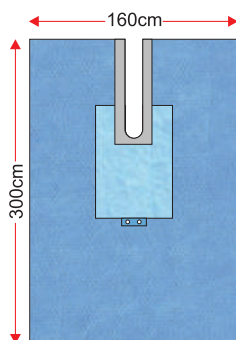

Product Name Medimaf - Universal U Drape

Size 300cm * 160cm

Product Code MFUD3016

Description

Medimaf Universal U Drape of size 300cm * 160cm having U Split 10cm * 80cm with adhesive around U split, reinforced with laminated spunlace absorbent around the split, help to manage fluid absorbency, supported with tube holder for tube and cord organiser.

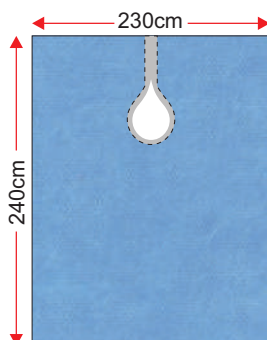

Product Name Medimaf - HIP O Drape

Size 230cm * 240cm

Product Code MFHE2324

Description

Medimaf Hip U Drape of size 230cm * 240cm, having straight split of 2cm * 20 cm, round cut of 24 cm with adhesive around straight and round-cut, backdrop of the drape reinforced for fluid repellency,

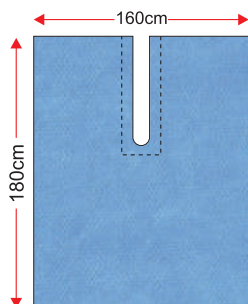

Product Name Medimaf -Split U Drape

Size 180cm * 160cm

Product Code MFSU1816

Description

Medimaf Split U Drape of size 180cm * 160cm, having U Split 10cm * 60cm with adhesive around U split, backdrop reinforced for fluid repellency.

HIP DRAPES

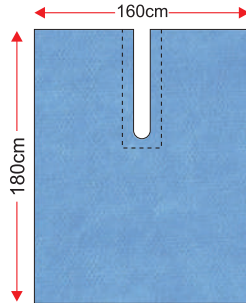

Product Name Medimaf -Impervious Split Drape

Size 180cm * 160cm

Product Code MFIS1816

Description

Medimaf Impervious split drapes of size 180cm * 160cm are made from laminated SMS non woven fabric, having U Split of 10cm * 60cm with adhesive around U split.

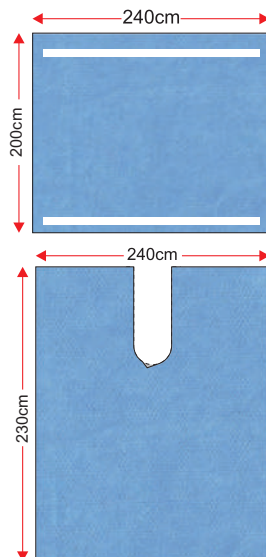

Product Name Medimaf -Hip U Drape Eco with Screen Drape

Size HIP U drape Eco 230cm * 240cm
Screen Drape 240cm * 200cm

Product Code MFHBS2324

Description

Medimaf Hip U Drape Eco of size 230cm * 240cm, having U Split 25 cm * 45 cm with adhesive around U split, backdrop reinforced for managing fluid penetration and concentration, supported with screen drape or head sheet of size 240cm * 200cm with adhesive on both edges

HIP DRAPES

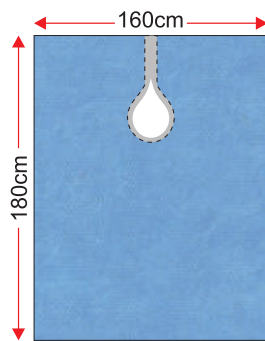
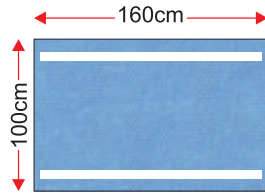

Product Name

Medimaf -Hip U Drape with Screen Drape

Size

HIP O drape Eco 230cm * 240cm
Screen Drape 100cm * 160cm

Product Code

MFHES2324

Description

Medimaf Hip O Drape of size 200cm * 160cm, having straight split of 2cm * 20 cm, round cut of 24 cm with adhesive around straight split and round-cut, the backdrop of the drape reinforced for fluid repellency, supported with a head sheet or screen sheet of size 100cm * 160cm having adhesive on both edges

KNEE DRAPES

Medimaf Knee drapes made from polypropylene SMMS non-woven fabric, absorbent non-woven fabric, helps to isolate the surgical site from the other areas of the patient's body and nonsterile areas of the OR table to contribute to reducing the risk of surgical site infection (SSI). The fabrics meet IS17334, AAMI PB 70, EN13795 standards. The fabric used in making the drapes are resistant to fluid penetration, fluid concentration, and blood strike-through, they are free from skin irritation, skin sensitization, and cytotoxicity.^{**2*} also resist microbial penetration^{**3*}, virtually lint-free, and abrasion-resistant^{**4*}. Knee drapes are pouch packed in certified and validated packs that meet EN868 -5 and ISO 11607-1 standard^{**5*} and finally, EO Sterilised as per ISO 11135 standards.^{**6*}

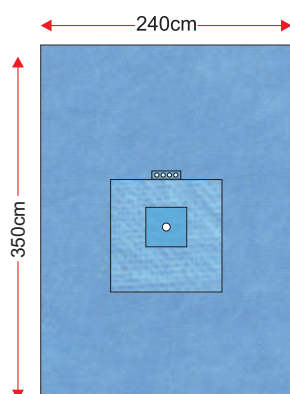

Product Name Medimaf - Knee O Drape Ultra

Size 350cm * 240cm

Product Code MFKOP3524

Description

Medimaf Knee O Drape Ultra of size 350cm * 240cm, reinforced with premium SMPE absorbent fabric and latex-free material having a center hole of 2.5-inch diameter, supported with tube holder for tube and cord organizer

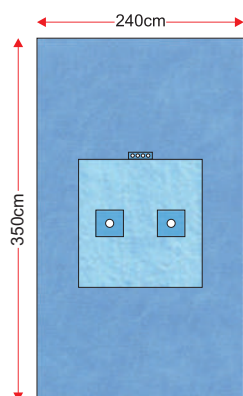

Product Name Medimaf - Bilateral Knee O Drape SD

Size 350cm * 240cm

Product Code MFBKD3524

Description

Medimaf Bilateral Knee O Drape SD of size 360cm * 240cm reinforced with laminated spunlace absorbent fabric and 2 latex free material having center hole of 2.5 inch diameter, supported with tube holder for tube and cord organiser.

KNEE DRAPES

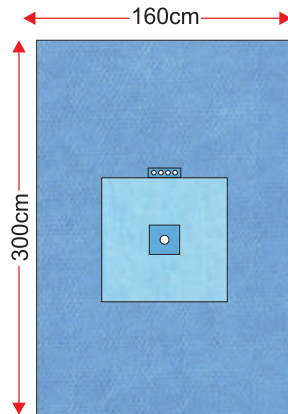

Product Name Medimaf - Universal Extremity Drape

Size 300cm * 160cm

Product Code MFUE3016

Description

Medimaf Universal Extremity Drape of size 300cm * 160cm, reinforced with laminated spunlace absorbent fabric and latex-free material having a center hole of 2.5-inch diameter, supported with tube holder for tube and cord organizer

LAMINO SPINAL DRAPES

Medimaf Lamino Spinal drapes made from polypropylene SMMS non-woven fabric, absorbent non-woven fabric, helps to isolate the surgical site from the other areas of the patient's body and nonsterile areas of the OR table to contribute to reducing the risk of surgical site infection (SSI). The fabrics meet IS17334, AAMI PB 70, EN13795 standards ^{*c1)} The fabric used in making the drapes are resistant to fluid penetration, fluid concentration, and blood strike-through, they are free from skin irritation, skin sensitization, and cytotoxicity.^{**2)} also resist microbial penetration^{***3)}, virtually lint-free, and abrasion-resistant^{****4)}. Lamino Spinal drapes are pouch packed in certified and validated packs that meet EN868 -5 and ISO 11607-1 standard^{**5)} and finally, EO Sterilised as per ISO 11135 standards.

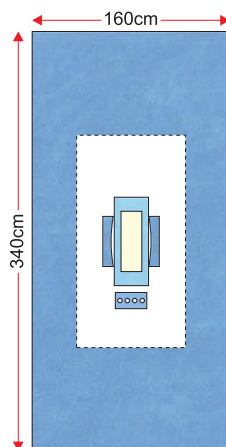

Product Name Medimaf - Lamino Spinal Drape SD

Size 340cm * 160cm

Product Code MFLSD3416

Description

Medimax Lamino Spinal drape SD of size 340cm * 160cm, having fenestration size of 35 cm * 17 cm with incise film and adhesive tape around fenestration, reinforced with spunlace absorbent around fenestration, backdrop reinforced for better protection from fluid penetration and concentration, supported with 2 pockets for placing instruments, tube holders for the tube, and a cord organizer.

ORTHOPAEDIC DRAPES

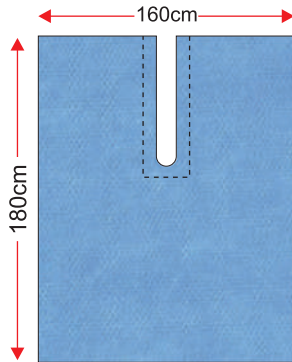

Product Name Medimaf - Split U Drape

Size 180cm * 160cm

Product Code **MFSU1816**

Description

Medimaf Split U Drape of size 180cm * 160cm, having U Split 10cm * 60cm with adhesive around U split, backdrop reinforced for fluid repellency, supported with tube holders for tube and cord organiser.

SHOULDER DRAPES

Medimaf Shoulder U drapes made from polypropylene SMMS non-woven fabric, absorbent non-woven fabric, helps to isolate the surgical site from the other areas of the patient's body and nonsterile areas of the OR table to contribute to reducing the risk of surgical site infection (SSI). The fabrics meet IS17334, AAMI PB 70, EN13795 standards. The fabric used in making the drapes are resistant to fluid penetration, fluid concentration, and blood strike-through, they are free from skin irritation, skin sensitization, and cytotoxicity. They also resist microbial penetration, virtually lint-free, and abrasion-resistant. Shoulder U drapes are pouch packed in certified and validated packs that meet EN868 -5 and ISO 11607-1 standard and finally, EO Sterilised as per ISO 11135 standards

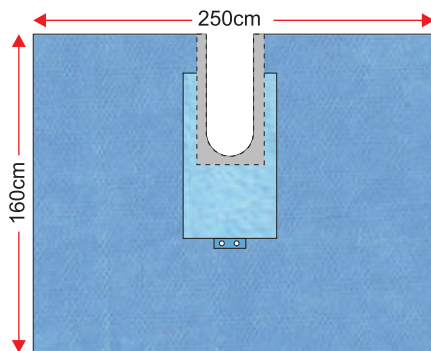

Product Name Medimaf - Shoulder U Drape SD

Size 250cm * 160cm

Product Code **MFSU2516**

Description

Medimaf Shoulder U Drape SD of size 250cm * 160cm, having U Split 25cm * 45cm with adhesive around U split, reinforced with spunlace absorbent layer around the split, helps to manage fluid absorbency. Supported with tube holder for tube and cord organizer

SHOULDER DRAPES

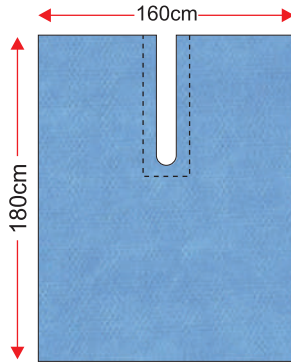

Product Name Medimaf - Split U Drape

Size 180cm * 160cm

Product Code MFSU1816

Description

Medimaf Split U Drape of size 180cm * 160cm, having U Split 10cm * 60cm with adhesive around U split, backdrop reinforced for fluid repellency, supported with tube holders for tube and cord organiser.

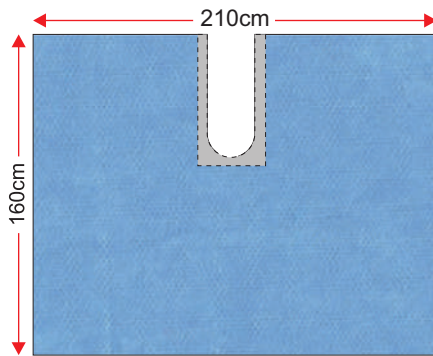

Product Name Medimaf - Shoulder U Drape Neo

Size 210cm * 160cm

Product Code MFSUB2110

Description

Medimaf Shoulder U Drape Neo of size 210cm * 160cm, having U Split 25cm * 45cm with adhesive around U split, backdrop reinforced for managing fluid penetration and concentration.

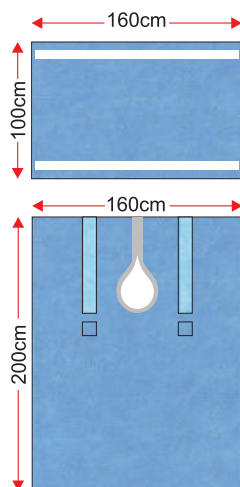

Product Name Medimaf - Shoulder U Drape Eco with Screen Drape

Size Shoulder U Drape Eco 210cm * 160cm
Screen Drape 100cm * 160cm

Product Code MFSES2016

Description

Medimaf Shoulder U Drape Eco of size 200cm * 160cm, having straight split of size 2cm * 15cm and a round cut 16cm, with adhesive around U cut, backdrop reinforced for fluid repellency, supported with absorbent pads 50cm * 10 cm across U cut and 2 tube holders, supported with a head sheet or screen sheet of size 160cm * 100cm having adhesive on both edges

ORTHOPAEDIC EXTREMITY PROCEDURE PACK



Hand Towel



Assure RI*



Cling Drape

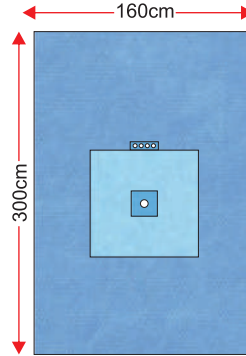

Universal Extremity Drape

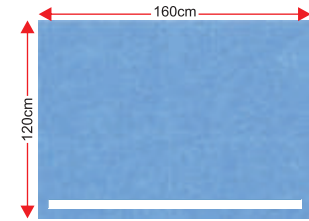

Plain Drape Sheet with adhesive (Medium Sheet)

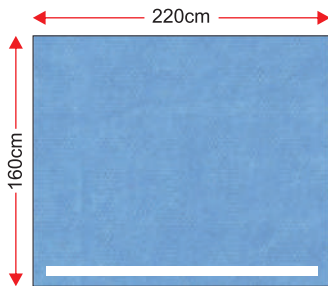

Plain Drape Sheet with Adhesive (Large Sheet)



Instrument / Cautery Bag



C- Arm Drape



Trolley / Back Table Cover



Trolley / Back Table Cover Reinforced

Pack Code		MF09004S		
Pack Name		Medimaf* - Ortho Extremity Procedure Pack		
S.no	Product Description	Product Code	Product Size	Qty.
1	Medimaf Assure RI*	MFSGAR02M43 MFSGAR02L43	Medium Large	3
2	Medimaf* - Hand Towel	MFHT3030	30 cm * 30 cm	6
3	Medimaf* - Cling Drape	MFCNG01	Width 15 cm * Length 5 mtr	1
4	Medimaf* - Universal Extremity Drape	MFUE3016	300 cm * 160 cm	1
5	Medimaf* - Plain Drape Sheet with Adhesive (Large Sheet)	MFDWA221643	220 cm * 160 cm	2
6	Medimaf* - Plain Drape Sheet with Adhesive (Medium Sheet)	MFDWA161243	120 cm * 160 cm	1
7	Medimaf* - Instrument / cautery Bag	MFCB01	40 cm * 40 cm	1
8	Medimaf* - C- Arm Drape	MFCAC011P	Standard 1 Piece	1
9	Medimaf* - Trolley / Back Table Cover	MFTSS8075	80 cm * 75 cm (Small)	1
10	Medimaf* - Trolley / Back Table Cover Reinforced	MFTRL160225	160 cm * 225 cm (Large)	1

BILATERAL KNEE ARTHROPLASTY ULTRA DRAPE PROCEDURE PACK



Hand Towel



Assure RI*



Impervious Stockinette



OP Release Tape

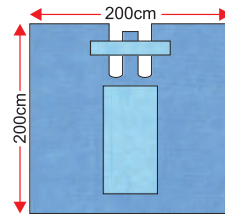

Bilateral Under Leg Drape

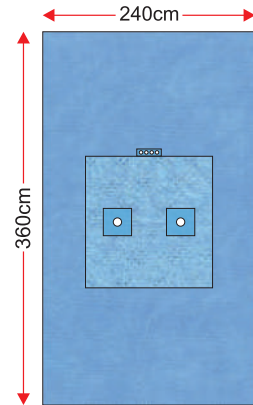

Bilateral Knee O Drape Ultra

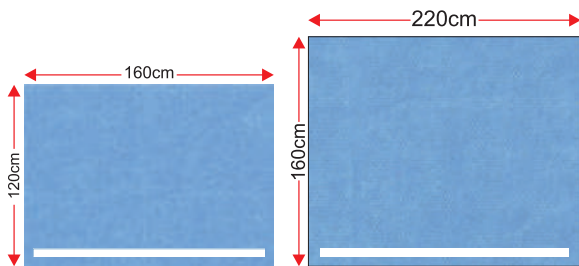

Plain Drape Sheet with adhesive (Medium Sheet)

Plain Drape Sheet with Adhesive (Large Sheet)



Instrument / Cautery Bag



C- Arm Drape



Trolley / Back Table Cover



Trolley / Back Table Cover Reinforced

Pack Code		MF0902003S		
Pack Name		Medimaf* - Bilateral Knee Arthroplasty Ultra Drape Pack		
S.no	Product Description	Product Code	Product Size	Qty.
1	Medimaf Assure RI*	MFSGAR02M43 MFSGAR02L43	Medium Large	4
2	Medimaf* - Hand Towel	MFHT3030	30 cm * 30 cm	8
3	Medimaf* - Impervious Stockinette	MFSK01S	80 Cm * Dia 15 cm	2
4	Medimaf* - OP Release Tape	MFOP0515	5 cm * 15 cm	6
5	Medimaf* - Bilateral Under Leg Drape	MFBL2020	200 cm * 200 cm	1
6	Medimaf* - Bilateral Knee O Drape Ultra	MFBKP3624	360 cm * 240 cm	1
7	Medimaf* - Plain Drape Sheet with Adhesive (Large Sheet)	MFDWA221643	220 cm * 160 cm	2
8	Medimaf* - Plain Drape Sheet with Adhesive (Medium Sheet)	MFDWA161243	160 cm * 120 cm	1
9	Medimaf* - Instrument / Cautery Bag	MFCB01	40 cm * 30 cm	2
10	Medimaf* - C - Arm Drape	MFCAC012P	Standard 1 Pair	1
11	Medimaf* - Trolley / Back Table Cover	MFTSS8075	80 cm * 75 cm (Small)	1
12	Medimaf* - Trolley / Back Table Cover	MFTSL16225	160 cm * 225 cm (Large)	1
13	Medimaf* - Trolley / Back Table Cover Reinforced	MFTRL16225	160 cm * 225 cm (Large)	1

KNEE ARTHROSCOPY PROCEDURE ECO PACK



Hand Towel

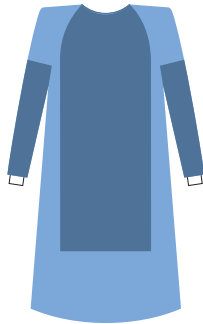

Assure RI*



Cling Drape



OT Tape

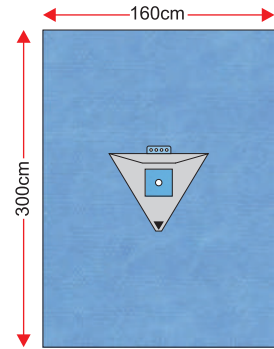

Knee Arthroscopy Drape SD



Plain Drape Sheet without adhesive (Medium)

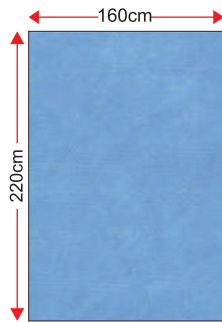

Plain Drape Sheet without adhesive (Large)



Instrument / Cautery Bag



Trolley / Back Table Cover

Pack Code		MF0903003S		
Pack Name		Medimaf* - Knee Arthroscopy Eco Pack		
S.no	Product Description	Product Code	Product Size	Qty.
1	Medimaf Assure RI*	MFSGAR02M43 MFSGAR02L43	Medium Large	3
2	Medimaf* - Hand Towel	MFHT3030	30 cm * 30 cm	6
3	Medimaf* - Cling Drape	MFCNG01	Width 15 cm * Length 5 mtr	1
4	Medimaf* - OP Release Tape	MFOP0515	5 cm * 15 cm	4
5	Medimaf* - Knee Arthroscopy Drape SD	MFKAD3016	300 cm * 160 cm	1
6	Medimaf* - Plain Drape Sheet without Adhesive (Large Sheet)	MFDA221643	220 cm * 160 cm	1
7	Medimaf* - Plain Drape Sheet without Adhesive (Medium Sheet)	MFDA121643	160 cm * 120 cm	1
8	Medimaf* - Instrument / Cautery Bag	MFCB01	40 cm * 30 cm	1
9	Medimaf* - Trolley / Back Table Cover	MFTSS8075	80 cm * 75 cm (Small)	1
10	Medimaf* - Trolley / Back Table Cover	MFTSL16225	160 cm * 225 cm (Large)	1

LAMINO SPINAL PROCEDURE SD DRAPE PACK



Hand Towel



Assure RI*

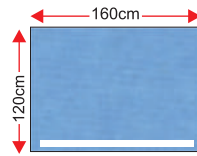

Plain Drape Sheet with adhesive (Medium Sheet)

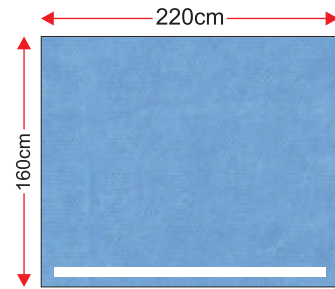

Plain Drape Sheet with Adhesive (Large Sheet)

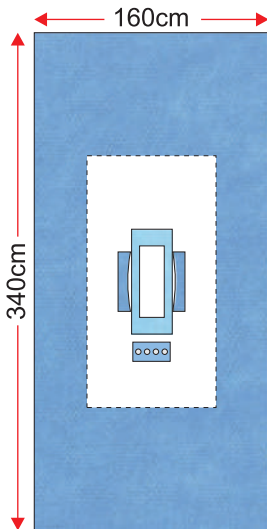

Lamino Spinal Drape SD



C-Arm Drape



Mayo Trolley Cover Reinforced



Trolley / Back Table Cover



Trolley / Back Table Cover Reinforced

Pack Code		MF06003S		
Pack Name		Medimaf* - Lamino Spinal SD Drape Pack		
S.no	Product Description	Product Code	Product Size	Qty.
1	Medimaf Assure RI*	MFSGAR02M43 MFSGAR02L43	Medium Large	3
2	Medimaf* - Hand Towel	MFHT3030	30 cm * 30 cm	6
3	Medimaf* - Plain Drape Sheet with Adhesive (Medium Sheet)	MFDWA161243	160 cm * 120 cm	2
4	Medimaf* - Plain Drape Sheet with Adhesive (Large Sheet)	MFDWA221643	220 cm * 160 cm	2
5	Medimaf* - Lamino Spinal Drape SD	MFLSD3416	340 cm * 160 cm	1
6	Medimaf* - C - Arm Drape	MFCAC012P	Standard 1 Pair	1
7	Medimaf* - Mayo Trolley Cover Reinforced	MFMTTR8080	80 cm * 80 cm	2
8	Medimaf* - Trolley / Back Table Cover Reinforced	MFTRM1615	160 cm * 150 cm (Medium)	1
9	Medimaf* - Trolley / Back Table Cover Reinforced	MFTRL16225	160 cm * 225 cm (Large)	1

SHOULDER ARTHROSCOPY PROCEDURE SD DRAPE PACK



Pack Code		MF0905001S		
Pack Name		Medimaf* - Shoulder Arthroscopy SD Drape Pack		
S.no	Product Description	Product Code	Product Size	Qty.
1	Medimaf Assure RI*	MFSGAR02M43 MFSGAR02L43	Medium Large	3
2	Medimaf* - Hand Towel	MFHT3030	30 cm * 30 cm	6
3	Medimaf* - Impervious Stockinette	MFSK01S	80 Cm * Dia 15 cm	1
4	Medimaf* - OP Release Tape	MFOP0515	5 cm * 15 cm	4
5	Medimaf* - Split U Drape	MFSU1816	180 cm * 160 cm	1
6	Medimaf* - Shoulder Arthroscopy Drape SD	MFSAD2516	250 cm * 160 cm	1
7	Medimaf* - Plain Drape Sheet with Adhesive (Large Sheet)	MFDWA221643	220 cm * 160 cm	2
8	Medimaf* - Instrument / Cautery Bag	MFCB01	40 cm * 30 cm	1
9	Medimaf* - Endoscopy / Camera Drape	MFEDC01	Width 15 cm * Length 250 cm	1
10	Medimaf* - Trolley / Back Table Cover	MFTSS8075	80 cm * 75 cm (Small)	1
11	Medimaf* - Trolley / Back Table Cover Reinforced	MFTRL16225	160 cm * 225 cm (Large)	2

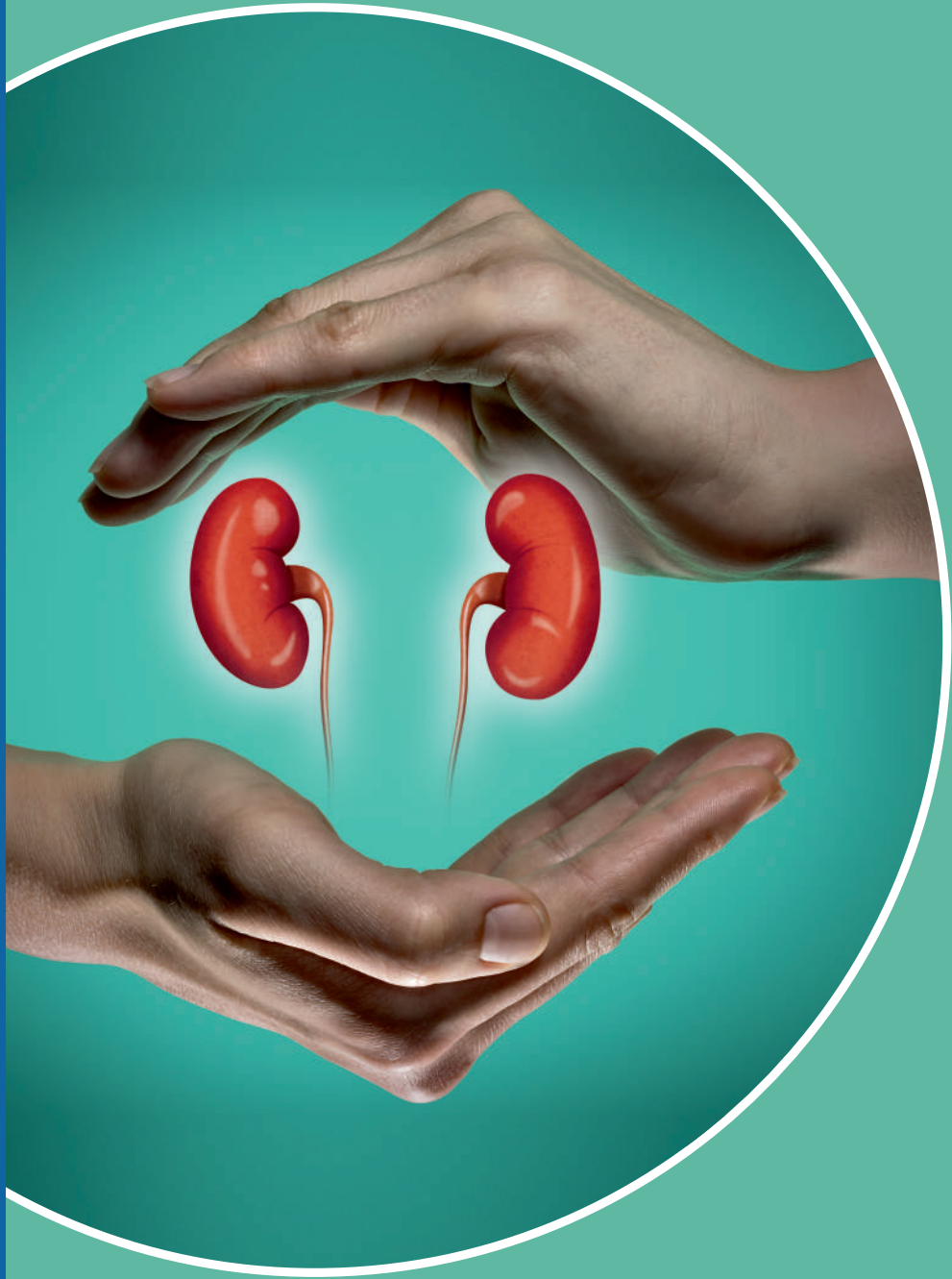

UROLOGY

DRAPES & PACKS

UROLOGY DRAPES

Medimaf Urology drapes made from polypropylene SMMS non-woven fabric, absorbent non-woven fabric, helps to isolate the surgical site from the other areas of the patient's body and nonsterile areas of the OR table to contribute to reducing the risk of surgical site infection (SSI). The fabrics meet IS17334, AAMI PB 70, EN13795 standards. The fabric used in making the drapes are resistant to fluid penetration, fluid concentration, and blood strike-through, they are free from skin irritation, skin sensitization, and cytotoxicity.*¹² also resist microbial penetration*¹³, virtually lint-free, and abrasion-resistant*¹⁴. Urology drapes are pouch packed in certified and validated packs that meet EN868 -5 and ISO 11607-1 standard*¹⁵ and finally, EO Sterilised as per ISO 11135 standards

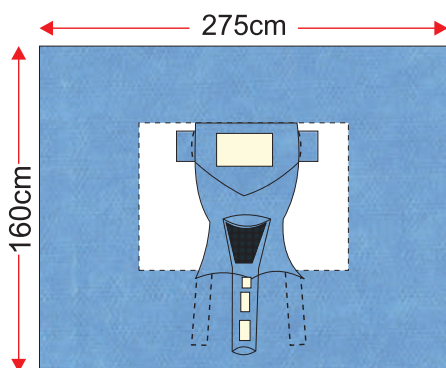

Product Name Medimaf - PCNL Drape

Size 275cm * 160cm

Product Code **MFPD27516**

Description

Medimaf PCNL Drape of size 275cm * 160cm having Fenestration of size 25cm * 25cm with incise film and adhesive around fenestration. Backdrop reinforced for enhanced protection from fluid penetration and concentration during surgery. Supported with funnel having mesh to collect the debris, having sipral wire for drain tube with adhesive to stick the drain tube also supported with tube holders for tube and cord organiser

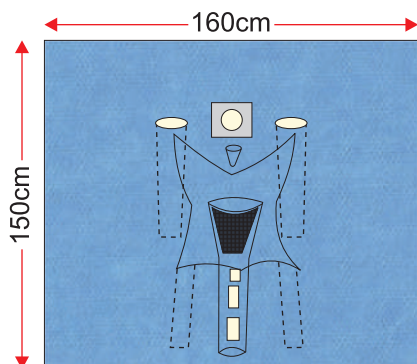

Product Name Medimaf - TURP Drape

Size 160cm * 150cm

Product Code **MFTD1616**

Description

Medimaf TURP Drape of Size 160cm * 150cm, having circular fenestration 8 cm diameter with adhesive around fenestration, having finger cot at 6" from the hole, provided with 2 attached leggings on both side of fenestration. Funnel with mesh net having sipral wire for drain tube with adhesive to stick the drain tube

UROLOGY DRAPES

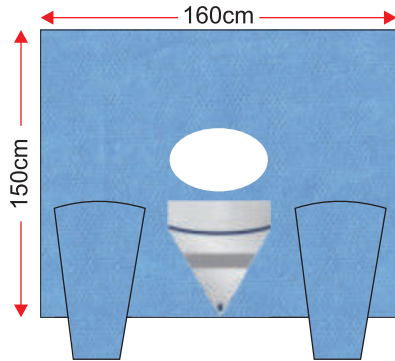

Product Name Medimaf - Lithotomy Drape

Size 160cm * 150cm

Product Code **MFLTD1615**

Description

Medimaf Cystoscopy Drape of size 160cm * 150cm, having circular fenestration of 8cm diameter with adhesive around fenestration. Supported with attached leggings and fluid collection pouch with a suction port.

LAPAROSCOPIC UROLOGY DRAPES

Medimaf Laparoscopy drapes made from polypropylene SMMS non-woven fabric, absorbent non-woven fabric, helps to isolate the surgical site from the other areas of the patient's body and nonsterile areas of the OR table to contribute to reducing the risk of surgical site infection (SSI). The fabrics meet IS17334, AAMI PB 70, EN13795 standards. The fabric used in making the drapes are resistant to fluid penetration, fluid concentration, and blood strike-through, they are free from skin irritation, skin sensitization, and cytotoxicity.^{m2i} also resist microbial penetration^{m3i}, virtually lint-free, and abrasion-resistant^{m4i}. Laparoscopy drapes are pouch packed in certified and validated packs that meet EN868 -5 and ISO 11607-1 standard^{m5i} and finally, EO Sterilised as per ISO 11135 standards

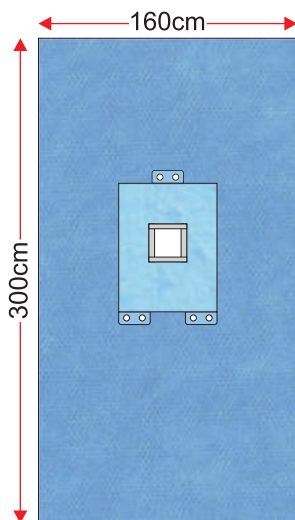

Product Name Medimaf - Laparoscopy Drape

Size 300cm * 160cm

Product Code **MFLD3016**

Description

Medimaf Laparoscopy Drape of size 300cm * 160cm having fenestration size 30cm * 30cm with adhesive around fenestration, reinforced with spunlace absorbent laminated around fenestration for better fluid absorbency, supported with tube holder for tube and cord organiser.

PCNL PROCEDURE PACK



Hand Towel



Assure RI*

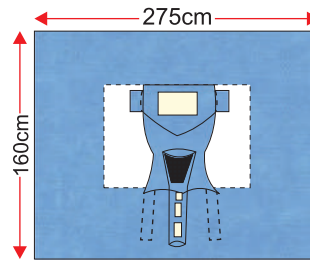

PCNL Drape



Instrument / Cautery Bag



Endoscopy / Camera Drape



C- Arm Drape



Mayo Trolley Cover Reinforced



Trolley / Back Table Cover Reinforced

Pack Code	MF10001S			
Pack Name	PCNL Procedure Pack			
S.no	Product Description	Product Code	Product Size	Qty.
1	Medimaf Assure RI*	MFSGAR02M43 MFSGAR02L43	Medium / Large	3
2	Medimaf* - Hand Towel	MFHT3030	30cm * 30cm	6
3	Medimaf* - PCNL Drape	MFPD27516	275cm * 160cm	1
4	Medimaf* - Instrument / Cautery Bag	MFCB01	40cm * 30cm	1
5	Medimaf* - Endoscopy / Camera Drape	MFEDC01	Width 15cm * Length 250cm	1
6	Medimaf* - C - Arm Drape	MFCAC012P	Standard 1 Pair	1
7	Medimaf* - Mayo Trolley Cover Reinforced	MFMTTR8080	80cm * 80cm	1
8	Medimaf* - Trolley / Back Table Cover Reinforced	MFTRL16225	160cm * 225cm (Large)	1

TURP PROCEDURE PACK



Hand Towel

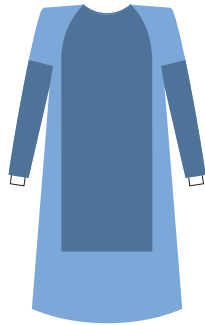

Assure RI*

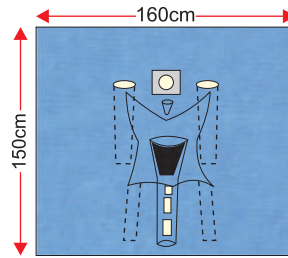

TURP Drape

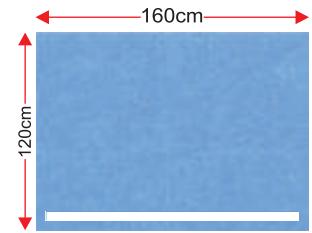

Plain Drape Sheet With Adhesive (Medium Sheet)



Endoscopy / Camera Drape



Mayo Trolley Cover Reinforced



Trolley / Back Table Cover Reinforced

Pack Code		MF10002S		
Pack Name		TURP Procedure Pack		
S.no	Product Description	Product Code	Product Size	Qty.
1	Medimaf Assure RI*	MFSGAR02M43 MFSGAR02L43	Medium / Large	3
2	Medimaf* - Hand Towel	MFHT3030	30cm * 30 cm	6
3	Medimaf* - TURP Drape	MFTD1615	160 cm * 150 cm	1
4	Medimaf* - Plain Drape Sheet with adhesive (medium sheet)	MFDWA161243	160 cm * 120 cm	1
5	Medimaf* - Endoscopy / Camera Drape	MFEDC01	Width cm * Length 250 cm	1
6	Medimaf* - Mayo Trolley Cover Reinforced	MFMTR8080	80 cm * 80 cm	1
7	Medimaf* - Trolley / Back Table Cover Reinforced	MFTRL16225	160 cm * 225 cm (Large)	1

MEDIMAF HIV KIT



Hand Towel



Boot Leggings



Surgeon Gloves

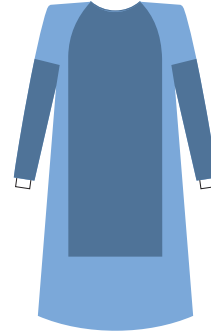

Assure RI*



Surgeon Face Mask



Hood Cap



Goggles (P)



Plain Sheet /
Hygiene Sheet



Disposable Bag (Yellow)

Pack Code		MFA002S		
Pack Name		Medimaf* HIV KIT		
S.no	Product Description	Product Code	Product Size	Qty.
1	Medimaf Assure RI*	MFSGAR02M43 MFSGAR02L43	Medium Large	1
2	Medimaf* - Hand Towel	MFHT3030	30 cm * 30 cm	1
3	Medimaf* - Surgeon Face Mask	MFFM01	Standard	1
4	Medimaf* - Hood Cap	MFHC01	Standard	1
5	Medimaf* - Goggles	MFGG01		1
6	Surgeon Gloves	MFSGG01		1 Pair
7	Medimaf* - Plain Sheet / Hygiene sheet	MFPS01L	120 cm * 210 cm (Large)	2
8	Medimaf* - Boot Leggings	MFBL01	Standard	1 Pair
9	Medimaf* - Disposable bag (Yellow)	MFDSB01		1



ACCESSORIES

MEDICAL ACCESSORIES



Product Name	Instrument / Cautery Bag
Product Code	MFCB01
Size	40cm * 30cm
Description	Sterile disposable pouch made from non woven fabric with adhesive tape across edges for attaching the pouch to the patient drapes, helps in managing handy surgical instruments during surgery.



Product Name	Trolley / Back Table Cover / Basin Stand
Product Code	MFTSS8075 Size : 80cm * 75cm (Small)
	MFTBS8010 Size : 80cm * 100cm (Basin Stand)
	MFTSM1615 Size : 160cm * 150cm (Medium)
	MFTSL16225 Size : 160cm * 225cm (Large)
Description	Sterile disposable SS laminated, impervious instrument trolley or back table drape, available in small, medium and large size.



Product Name	Trolley / Back Table Cover Reinforced
Product Code	MFTRM1615 Size : 160cm * 150cm (Medium)
	MFTRL16225 Size : 160cm * 225cm (Large)
Description	Sterile disposable SS laminated, impervious instrument trolley or back table drape, available in small, medium and large size. Reinforced for better protection.



Product Name	Mayo Trolley Cover
Product Code	MFMTTC1480 Size : 140cm * 80cm (Large)
	MFMTTC8080 Size : 80cm * 80cm (Small)
Description	Disposable SS laminated Mayo trolley drape.



Product Name	Mayo Trolley Cover Reinforced
Product Code	MFMTR1480 Size : 140cm * 80cm (Large)
	MFMTR8080 Size : 80cm * 80cm (Small)
Description	Disposbale SS laminated, impervious Mayo trolley drape, additionally reinforced with absorbent layer.



Product Name	C- Arm Drape
Product Code	MFCAC011P Size : Standard - 1 Piece
	MFCAC012P Size : Standard - 1 Pair
Description	Medimaf C-Arm Drape, are made from LDPE material, helps to protect the equipment and manage visibility of equipment.



Product Name	C-Arm Drape Full
Product Code	MFCAC013P
Size	Standard - 3 Piece
Description	Medimaf C-Arm Drape full, are made from LDPE material and or non-woven fabric, helps to protect the equipment and manage visibility of equipment.



Product Name	Endoscopy / Camera Drape
Product Code	MFEDC01
Size	Dia 15cm* Length 250cm
Description	Medimaf Endoscopy / Camera Drape are made from LDPE material, helps to protect the equipment and manage visibility of equipment.



Product Name	Ultrasound Probe Drape
Product Code	MFUS01
Size	Dia 15cm* Length 250cm
Description	Medimaf Ultrasound Probe Drape are made from LDPE material, helps to protect the equipment and manage visibility of equipment.



Product Name	Surgical Microscope Drape
Product Code	MFSM01 Size : Width 120cm* Length 300cm MFSM02 Size : Width 120cm* Length 270cm
Description	Medimaf Surgical Microscope Drape are made from PE material, helps to protect the equipment and manage visibility of equipment.



Product Name	Hand Towel
Product Code	MFHT3030
Size	30cm * 30cm
Description	Soft non woven spunlace fabric for assured hygiene.



Product Name	Cling Drape
Product Code	MFCNG01 MFCNG02
Size	Width 15cm* Length 5mtr Width 15cm* Length 10mtr
Description	Transparent natural colour low density PE film, used to drape extremities during surgical procedures



Product Name	Impervious Stockinette	
Product Code	MFSK01S	Size : 80cm * Dia 15cm
	MFSK01L	Size : 120cm * Dia 15cm
Description	Ribbed kintted cotton Stockinette for draping extremities during surgical procedure. Enhanced with PE film to make it impervious.	

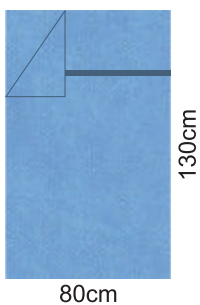

Product Name	Leggings
Product Code	MFLG01P
Size	130cm * 80cm
Description	Non woven SMS Fabric,used for draping legs during surgical procedure, provided as pair.



Product Name	OP Release Tape	
Product Code	MFOP4010	Size : 40cm *10cm
	MFOP0515	Size : 5cm *15cm
Description	SMS release sheets having adhesive on one side to secure drapes and covers in operation theater.	

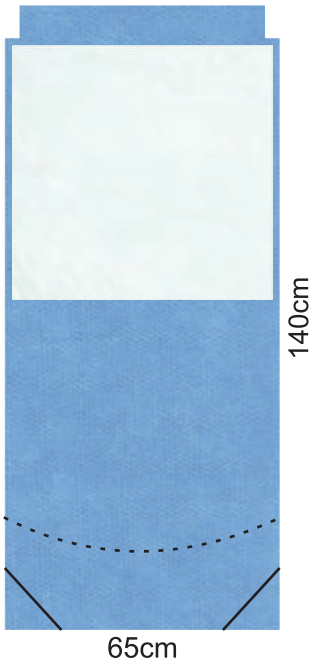

Product Name	Maternity Mat with Pouch
Product Code	MFMM1465
Size	140cm *65cm
Description	Maternity mat with pouch are laminated non woven fabric with attached absorbent underpad for fluid absorption, having a pouch at the bottom from the same laminated non woven fabric for collecting excess draining fluid.

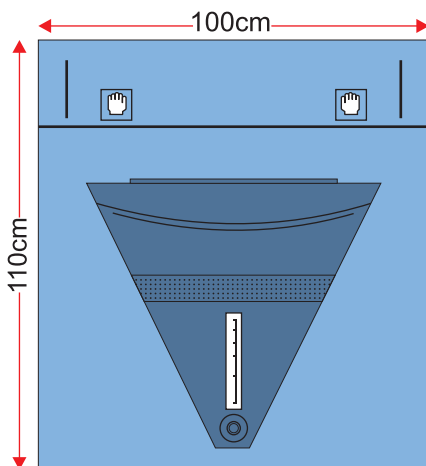

Underbuttock Drape

Product Name	Underbuttock Drape
Product Code	MFUBD1011
Size	100cm * 110cm
Description	Disposable underbuttock drape made from linear low density PE, with graduated fluid collection pouch with suction port.

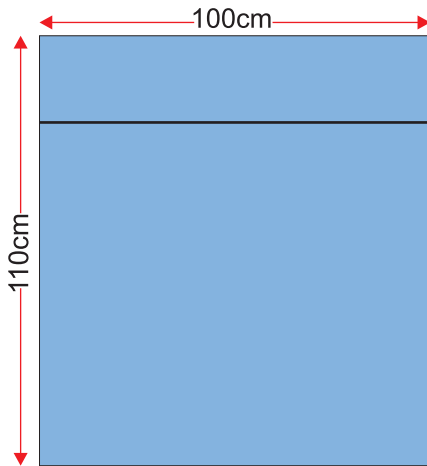

Underbuttock Drape

Product Name	Underbuttock Drape
Product Code	MF PUB1011
Size	100cm * 110cm
Description	Disposable underbuttock drape made from linear low density PE.



Product Name	Underbuttock Absorbent Pad
Product Code	MFUDP6090
Size	60cm * 90cm
Description	Disposable absorbent underbuttock pad.



Product Name	Poly Apron
Product Code	MFPA01
Size	Standard
Description	Aprons made of low density PE film to protect form fluid splashes

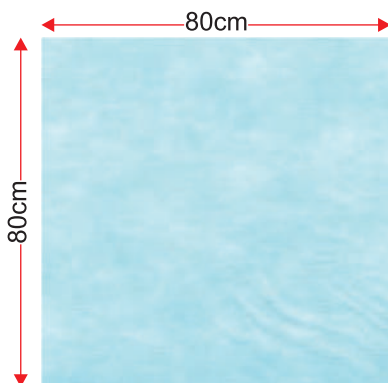

Baby Receiving Wrap

Product Name	Baby Receiving Sheet
Product Code	MFBRW01
Size	80cm * 80cm
Description	Wraps from virign non woven material for receiving and draping the new born baby.



Cord Clamp

Product Name	Cord Clamp
Product Code	MFCL01
Size	Standard
Description	Used for clamping the new born's umbilical cord



Product Name	Plain Sheet /Hygiene Sheet	
Product Code	MFPS01S	Size : 120cm * 60cm (Small)
	MFPS01M	Size : 120cm * 150cm (Medium)
	MFPS01L	Size : 120cm * 210cm (Large)
Description	Sterile disposable PE film sheets of 23-25 micron for multipurpose use available in white or medical blue colour.	



Product Name	Disposable Bed Sheet	
Product Code	MFBS16225	Size : 160cm * 225cm (Large)
	MFBS80225	Size : 80cm * 225cm (Small)
Description	Non Sterile disposable bed sheets made from non woven material	



Product Name	Disposable Pillow Cover	
Product Code	MFPC4880	
Size	48cm * 80cm	
Description	Non Sterile pillow covers made from non woven material	



Product Name	Disposable Bed Sheet and Pillow Cover Pack	
Product Code	MFBCP1680	Size : Bed sheet 160cm * 225cm, Size : Pillow Cover 48cm * 80cm
Description	Pack of non sterile disposable large bed sheet and pillow cover.	



Product Name	Operating Table Sheet (PE)	
Product Code	MFOT1260	Size : 120cm * 60cm (Small)
	MFOT1215	Size : 120cm * 150cm (Medium)
	MFOT1221	Size : 120cm * 210cm (Large)
Description	Sterile disposable Operating table sheets available in white or medical blue made of low density PE.	



Product Name	Operating Table Sheet (NW)	
Product Code	MFOTS1221	Size : 120cm * 150cm (Small)
	MFOTS1215	Size : 120cm * 210cm (Large)
Description	Sterile disposable Operating table sheets made from non woven fabric.	



Draw Sheet

Product Name	Draw Sheet
Product Code	MFDS1016
Size	100cm * 160cm
Description	Sterile non woven plain sheets for multipurpose use.



Product Name	Screen Drape
Product Code	MFSD2420 MFSD1612 MFSD1610
Size	240cm * 200cm 160cm * 120cm 160cm * 100cm
Description	Sterile non woven polypropylene drapes used as anesthesia screen or head drapes.

Isolation Gown



Product Name	Isolation Gown
Product Code	MFGIS01
Size	Standard
Description	Isolation gown meets AAMI level 1, helps to protect frontline caregivers and staff from infectious droplets, fluid penetration and solids.

Face Mask



Product Name	Face Mask
Product Code	MFFM01
Size	Standard
Description	3 Ply, disposable surgeon face mask, with nose piece, available in a pack of 100 nos.

Bouffant Cap



Product Name	Bouffant Cap
Product Code	MFBFC01
Size	Standard
Description	Disposable head caps, made from breathable light weight virgin non woven fabric with elasticated edge, available in a pack of 100 nos

Surgeon Cap



Product Name	Surgeon Cap
Product Code	MFSC01
Size	Standard
Description	Disposable breathable non woven surgeon caps, available in pack of 100 nos.

Goggles



Product Name	Goggles Goggles (P)
Product Code	MFGG01 (Premium) MFGG02 (Normal)
Description	Safety glasses to protect eyes from splashes, chemicals, etc.

Face Shield



Product Name	Face Shield
Product Code	MFFS01
Size	Universal
Description	Disposable face shield to protect from splashes, chemical etc.

Hood Helmet



Product Name	Hood Helmet
Product Code	MFHN01
Description	Disposable Hood helmet are made from poly propylene material with clear visor, helps to protect the surgeon and patient from bacterial infection.

Hood Cap



Product Name	Hood Cap
Product Code	MFHC01
Size	Universal
Description	Disposable non woven safety caps.

Boot Leggings



Product Name	Boot Leggings
Product Code	MFBL01
Size	Knee Length-Universal
Description	Disposable non woven boot leggings, knee length elasticated with ties to secure, available in pair.

Poly Boot Leggings



Product Name	Poly Boot Leggings
Product Code	MFBL02
Size	Knee Length - Universal
Description	Disposable poly boot leggings, knee length elasticated, available in pair.

Shoe Covers



Product Name	Shoe Covers
Product Code	MFSHC01
Size	Ankle Length -Universal
Description	Disposable non woven shoe covers, ankle length elasticated, available in pair.

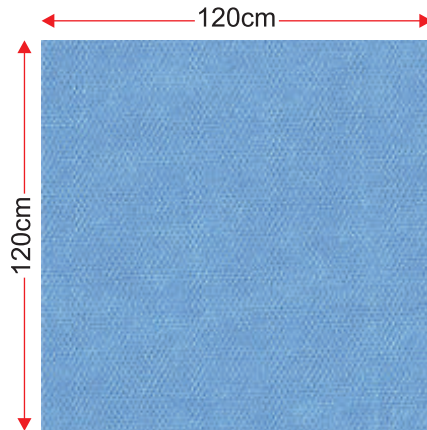

Medimaf Sterilisation Wraps are made from SMMMS fabric. The fabric is highly water repellent, has bacterial resistance and is durable, offering high bacterial resistance and blood repellency.

S.no	Product Code	Product Name	Size
1	MFSW505035	Sterilisation Wrap Sheet	50cm * 50cm
	MFSW505043		
	MFSW505050		
2	MFSW606035	Sterilisation Wrap Sheet	60cm * 60cm
	MFSW606043		
	MFSW606050		
3	MFSW757535	Sterilisation Wrap Sheet	75cm * 75cm
	MFSW757543		
	MFSW757550		
4	MFSW909035	Sterilisation Wrap Sheet	90cm * 90cm
	MFSW909043		
	MFSW909050		
5	MFSW101035	Sterilisation Wrap Sheet	100cm * 100cm
	MFSW101043		
	MFSW101050		
6	MFSW121235	Sterilisation Wrap Sheet	120cm * 120cm
	MFSW121243		
	MFSW121250		
7	MFSW151535	Sterilisation Wrap Sheet	150cm * 150cm
	MFSW151543		
	MFSW151550		
8	MFSW162035	Sterilisation Wrap Sheet	160cm * 200cm
	MFSW162043		
	MFSW162050		

MATERIAL COLOUR AND TEXTURE

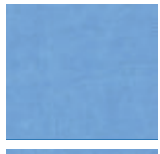

Adhesive tape



SMPE fabric



Breathable viral barrier fabric



SS laminated non woven fabric



Latex free Elastic Sheet



SMS laminated non woven fabric



PE Film



Sonatara repellent fabric



Plastic Sheet



SS non woven fabric



Polypropylene non woven fabric SMS / SMMS / SMMMS



Spunlace non woven fabric



Sontara absorbent fabric



Spunlace laminate non woven fabric



SINCE 1905
Mafatlal[®]



ARVIND MAFATLAL GROUP
 The ethics of excellence



One stop solution for all your General, Operation Room and CSSD needs.
 Please Book your appointment with one of our Product Specialist for all your Infection Control needs.

UNICHOICE[™]
 HOSPITAL WEAR



MEDIMAF[™]
 SURGICAL
 DISPOSABLE

MAFATLAL INDUSTRIES LIMITED

5th Floor, Mafatlal House, H. T. Parekh Marg, Backbay Reclamation, Churchgate, Mumbai - 400 020.
 Telephone: +91-22-6771 3800 / 3900, Fax: 67713924 / 25

Exclusive Manufacturers for Mafatlals

Manufacturing by:

MAFATLAL INDUSTRIES LIMITED

Post Box No. 55, Kapadvanj Road, Nadiad - 387001. Gujarat, India

You can reach us at:

Website : www.mafatlals.com / Customer care : +91 8657912847

Email : enquiry@mafatlalhealthcare.com

